



Step 1 V3 UDPP Final OSED

Document information

| | |
|------------------|------------------------------------|
| Project Title | Optimised Airspace User Operations |
| Project Number | 07.06.02 |
| Project Manager | EUROCONTROL |
| Deliverable Name | Step 1 V3 UDPP Final OSED |
| Deliverable ID | D66 |
| Edition | 00.02.01 |
| Template Version | 03.00.00 |

Task contributors

EUROCONTROL

Abstract

UDPP is the airspace user driven prioritization process that contributes to resolving a capacity constrained situation, either at an airport or in airspace. Through UDPP, airspace users have an opportunity to prioritize their flights to minimize the effects of delay.

Two SESAR solutions are supported by this OSED: Enhanced ATFM Slot Swapping (solution #56), and UDPP Departure (solution #57).

Authoring & Approval

| Prepared By - <i>Authors of the document.</i> | | |
|---|------------------|--------------------|
| Name & Company | Position & Title | Date |
| ██████████ EUROCONTROL | ██████████ | Continuous process |
| ██████████ EUROCONTROL | ██████████ | 13/11/2015 |

| Reviewed By - <i>Reviewers internal to the project (names in italics did not send back any comments)</i> | | |
|--|------------------|------------|
| Name & Company | Position & Title | Date |
| ██████████ <i>London Heathrow</i> | ██████████ | 07/09/2015 |
| ██████████ <i>DHL</i> | ██████████ | 07/09/2015 |
| ██████████ <i>DHL</i> | ██████████ | 07/09/2015 |
| ██████████ <i>SWISS</i> | ██████████ | 07/09/2015 |
| ██████████ <i>Austrian Airlines</i> | ██████████ | 07/09/2015 |
| ██████████ <i>Austrian Airlines</i> | ██████████ | 07/09/2015 |
| ██████████ <i>EBAA</i> | ██████████ | 07/09/2015 |
| ██████████ <i>IATA</i> ██████████ | ██████████ | 22/09/2015 |
| ██████████ <i>Lufthansa</i> | ██████████ | 07/09/2015 |
| ██████████ <i>American Airlines</i> | ██████████ | 07/09/2015 |
| ██████████ <i>HOP!</i> | ██████████ | 21/09/2015 |
| ██████████ <i>Turkish Airlines</i> | ██████████ | 07/09/2015 |
| ██████████ <i>British Airways</i> | ██████████ | 07/09/2015 |
| ██████████ <i>EUROCONTROL</i> | ██████████ | 07/09/2015 |

| Reviewed By - <i>Other SESAR projects, Airspace Users, staff association, military, Industrial Support, other organisations (names in italics did not send back any comments)</i> | | |
|---|------------------|------------|
| Name & Company | Position & Title | Date |
| ██████████ <i>Airbus</i> | ██████████ | 07/09/2015 |
| ██████████ <i>fly4D/Sabre</i> | ██████████ | 07/09/2015 |
| ██████████ <i>fly4D/Airbus</i> | ██████████ | 07/09/2015 |
| ██████████ <i>fly4D/Airbus</i> | ██████████ | 07/09/2015 |
| ██████████ <i>AIR FRANCE</i> | ██████████ | 07/09/2015 |
| ██████████ | ██████████ | 07/09/2015 |
| ██████████ <i>Air France</i> | ██████████ | 07/09/2015 |
| ██████████ <i>CRIDA</i> | ██████████ | 07/09/2015 |
| ██████████ <i>EUROCONTROL</i> | ██████████ | 10/09/2015 |
| ██████████ <i>SELEX</i> | ██████████ | 07/09/2015 |
| ██████████ <i>AVINOR</i> | ██████████ | 07/09/2015 |
| ██████████ <i>AIR FRANCE</i> | ██████████ | 07/09/2015 |
| ██████████ <i>Lufthansa Systems</i> | ██████████ | 07/09/2015 |
| ██████████ <i>EUROCONTROL</i> | ██████████ | 07/09/2015 |
| ██████████ | ██████████ | 07/09/2015 |

founding members



Avenue de Cortenbergh 100 | B -1000 Bruxelles
www.sesarju.eu

| Approved for submission to the SJU By - Representatives of the company involved in the project. | | |
|---|------------------|------------|
| Name & Company | Position & Title | Date |
| ██████████ EUROCONTROL | ██████████ | 29/09/2015 |
| ██████████ EUROCONTROL | ██████████ | 29/09/2015 |
| ██████████ ENAIRE | - | 28/09/2015 |
| ██████████ ENAV | - | 29/09/2015 |
| ██████████ ENAV | - | 26/09/2015 |
| ██████████ INDRA | - | 29/09/2015 |
| ██████████ THALES | - | 24/09/2015 |

| Rejected By - Representatives of the company involved in the project. | | |
|---|------------------|------|
| Name & Company | Position & Title | Date |
| - | - | - |

| Rationale for rejection |
|-------------------------|
| - |

Document History

| Edition | Date | Status | Author | Justification |
|------------|------------|--------|------------------------|---|
| 00.00.01 | 7/10/2011 | Draft | ██████████ EUROCONTROL | project scenario elements integration in initial draft Scenarios matrix (§5) |
| 00.00.02 | 20/10/2011 | Draft | ██████████ EUROCONTROL | Project comments |
| 00.00.03 | 25/10/2011 | Draft | ██████████ EUROCONTROL | Stabilisation §2.2, 4 |
| 00.00.04 | 10/11/2011 | Draft | ██████████ EUROCONTROL | Internal review comments Detailed scenarios (§5) |
| 00.00.04.2 | 18/11/2011 | Draft | ██████████ EUROCONTROL | Mapping tables (§2.1), exec sum, introduction |
| 00.00.05 | 01/12/2011 | Draft | ██████████ EUROCONTROL | Updated detailed scenarios (§5) |
| 00.00.06 | 08/02/2012 | Draft | ██████████ EUROCONTROL | -clarification of the scope (currently=swapping) in §2 and §3 -cleaning in §2 and §4 on Benefits and Performance -proposed Use Cases in §2 -integration of HK comments -additional UC in §5 reflecting FSFS principle |
| 00.00.07 | 04/07/2012 | Draft | ██████████ EUROCONTROL | OI steps redefinition Draft Section 5 Use Cases and scenarios |
| 00.00.08 | 31/07/2012 | Draft | ██████████ EUROCONTROL | Section 2, including Principles and Rules from ██████████, and Benefit Mechanism from ██████████ |
| 00.00.09 | 12/10/2012 | Draft | ██████████ EUROCONTROL | Section 3.1 included |
| 00.00.10 | 20/12/2012 | Draft | ██████████ EUROCONTROL | Chapter 3.2.1 included, with collaboration of ██████████ |
| 00.00.11 | 03/03/2013 | Draft | ██████████ EUROCONTROL | Chapter 3.2.2 included with collaboration of ██████████ Chapter 3.3 completed |

founding members



Avenue de Cortenbergh 100 | B -1000 Bruxelles
www.sesarju.eu

| Edition | Date | Status | Author | Justification |
|----------|------------|----------------------|---------------------------|---|
| | | | | Chapter 5 scenarios entirely refined Chapter 6 drafted |
| 00.00.12 | 21/04/2013 | Draft | ██████████ EUROCONTROL | Operational Requirements refined |
| 00.01.00 | 30/04/2013 | Interim Delivery | ██████████ EUROCONTROL | Reviewers comments partially integrated Formal interim deliverable to the SJU |
| 00.01.01 | 07/06/2013 | Interim Delivery (2) | ██████████ EUROCONTROL | Reviewers comments partially integrated Delivered to the SJU on 7 th June |
| 00.01.02 | 08/07/2013 | Interim Delivery (3) | ██████████ EUROCONTROL | SJU comments integrated Delivered to the SJU on 10 th July |
| 00.01.03 | 20/09/2013 | Interim Delivery | ██████████ EUROCONTROL | Integration of the Time-Reference swap concept |
| 00.01.04 | 24/11/2014 | Draft | ██████████ EUROCONTROL | Integration of the one-request combined Multi-swap; impact on STAM; pre-departure sequence at A-CDM; revision of Substitution on Cancellation and associated scenario |
| 00.01.05 | 05/09/2015 | Draft | ██████████ EUROCONTROL | Update after all Step 1 exercises have been completed and reported. |
| 00.01.06 | 24/09/2015 | Draft | ██████████ EUROCONTROL | Comments addressed from the final review. Document now sent out for approval. |
| 00.02.00 | 30/09/2015 | Final | ██████████ EUROCONTROL | Approved by the approvers. |
| 00.02.01 | 13/11/2015 | Final | ██████████ EUROCONTROL | Updated to reflect comments from the SJU. |

Intellectual Property Rights (foreground)

This deliverable consists of SJU Foreground.

founding members



Avenue de Cortenbergh 100 | B -1000 Bruxelles
www.sesarju.eu

Table of Contents

| | |
|---|-----------|
| TABLE OF CONTENTS | 5 |
| LIST OF TABLES | 7 |
| LIST OF FIGURES | 7 |
| EXECUTIVE SUMMARY | 9 |
| 1 INTRODUCTION | 10 |
| 1.1 PURPOSE OF THE DOCUMENT | 10 |
| 1.2 SCOPE | 10 |
| 1.3 INTENDED READERSHIP | 11 |
| 1.4 STRUCTURE OF THE DOCUMENT | 11 |
| 1.5 BACKGROUND..... | 12 |
| 1.6 GLOSSARY OF TERMS..... | 13 |
| 1.7 ABBREVIATIONS, ACRONYMS AND TERMINOLOGY..... | 13 |
| 2 SUMMARY OF OPERATIONAL CONCEPT FROM DOD | 16 |
| 2.1 MAPPING TABLES..... | 16 |
| 2.2 OPERATIONAL CONCEPT DESCRIPTION..... | 18 |
| 2.2.1 <i>Operational Concept Definition:</i> | 18 |
| 2.2.2 <i>Background:</i> | 19 |
| 2.2.3 <i>The problem statement:</i> | 19 |
| 2.2.4 <i>The Operational Concept basics</i> | 20 |
| 2.2.5 <i>UDPP principles</i> | 22 |
| 2.2.6 <i>The UDPP Step1 Expected Benefits</i> | 23 |
| 2.3 PROCESSES AND SERVICES (P&S) | 23 |
| 2.3.1 <i>Process PCS- 764 – DOD 07.02 Step1</i> | 24 |
| 2.3.2 <i>No Service identified in DOD 07.02 Step 1</i> | 25 |
| 3 DETAILED OPERATING METHOD | 26 |
| 3.1 PREVIOUS OPERATING METHOD..... | 26 |
| 3.1.1 <i>NM Operating method</i> | 26 |
| 3.1.2 <i>A-CDM operating method</i> | 42 |
| 3.1.3 <i>AUs Operating method</i> | 49 |
| 3.2 NEW SESAR OPERATING METHOD | 53 |
| 3.2.1 <i>The Time-Reference swap concept:</i> | 54 |
| 3.2.2 <i>ATFM Enhanced Slot Swapping:</i> | 59 |
| 3.2.3 <i>UDPP – Departure:</i> | 72 |
| 3.3 DIFFERENCES BETWEEN NEW AND PREVIOUS OPERATING METHODS..... | 78 |
| 3.3.1 <i>UDPP Step1: a reactive but iterative process</i> | 78 |
| 3.3.2 <i>Main Operational differences</i> | 79 |
| 3.3.3 <i>The cheating issue</i> | 83 |
| 3.3.4 <i>Impact of UDPP on HOTSPOTS</i> | 83 |
| 4 DETAILED OPERATIONAL ENVIRONMENT | 89 |
| 4.1 OPERATIONAL CHARACTERISTICS | 89 |
| 4.2 ROLES AND RESPONSIBILITIES..... | 89 |
| 4.3 CONSTRAINTS..... | 89 |
| 5 USE CASES | 90 |
| 5.1 OPERATIONAL SCENARIO 1 - EN-ROUTE DEMAND/CAPACITY IMBALANCE UNDER DEGRADATED SITUATION..... | 90 |
| 5.1.1 <i>USE CASE 1 - ATFM Slot Substitution on Cancellation</i> | 90 |
| 5.1.2 <i>USE CASE 2 - Multi-swap of ATFM Slot Swap</i> | 95 |

founding members



Avenue de Cortenbergh 100 | B -1000 Bruxelles
www.sesarju.eu

| | | |
|-------------------------|--|------------|
| 5.1.3 | USE CASE 3 – Pre-allocated Slot Swap..... | 99 |
| 5.1.4 | USE CASE 4 – Most Penalising Delay..... | 104 |
| 5.2 | OPERATIONAL SCENARIO 2 –DEMAND/CAPACITY IMBALANCE UNDER DEGRADED SITUATION AT DEPARTURE CDM AIRPORT..... | 109 |
| 5.2.1 | USE CASE 5 – Departure Reference-Time Reordering..... | 109 |
| 5.2.2 | USE CASE 6 – First Priority for Departure..... | 114 |
| 5.2.3 | USE CASE 7 –Upwards Cascade on Departure Cancellation..... | 118 |
| 6 | REQUIREMENTS..... | 123 |
| 6.1 | SAFETY & PERFORMANCE REQUIREMENTS (SPR)..... | 123 |
| 6.2 | INTEROPERABILITY REQUIREMENTS (IOP)..... | 123 |
| 6.3 | OPERATIONAL REQUIREMENTS FOR UDPP..... | 123 |
| 6.3.1 | Introducing the Requirement’s Identifier..... | 124 |
| 6.3.2 | Requirements That Apply to Enhanced Slot Swapping and UDPP Departure (i.e., Both SESAR Solutions)..... | 124 |
| 6.3.3 | Requirements for Enhanced ATFM Slot-Swapping (SESAR Solution #56)..... | 125 |
| 6.3.4 | Requirements for UDPP Departure (SESAR Solution #57)..... | 127 |
| 6.4 | INFORMATION EXCHANGE REQUIREMENTS..... | 128 |
| 7 | REFERENCES..... | 129 |
| 7.1 | APPLICABLE DOCUMENTS..... | 129 |
| 7.2 | REFERENCE DOCUMENTS..... | 129 |
| APPENDIX A | UDPP, HIGH LEVEL PRINCIPLES..... | 130 |
| APPENDIX B | | 131 |
| B.1 | NMOC SLOT-SWAPPING RULES AND CONSTRAINTS..... | 131 |
| APPENDIX C | EARLY CONSIDERATIONS OF THE BENEFITS..... | 133 |
| APPENDIX D | LATEST UNDERSTANDING OF THE BENEFITS..... | 139 |
| D.1 | FEATURE 1/7: PRE-ALLOCATED SLOT SWAP..... | 140 |
| D.2 | FEATURE 2/7: MULTI-SWAP OF ATFM SLOTS..... | 142 |
| D.3 | FEATURE 3/7: SUBSTITUTION ON CANCELLATION..... | 144 |
| D.4 | FEATURE 4/7: MOST PENALISING DELAY..... | 146 |
| D.5 | FEATURE 5/7: DEPARTURE REFERENCE-TIME REORDERING..... | 148 |
| D.6 | FEATURE 6/7: FIRST PRIORITY FOR DEPARTURE..... | 150 |
| D.7 | FEATURE 7/7: UPWARDS CASCADE ON DEPARTURE CANCELLATION..... | 152 |

List of tables

| | |
|---|-----|
| Table 1: List of relevant OIs within the OFA UDPP | 16 |
| Table 2: List of relevant DOD Scenarios and Use Cases..... | 17 |
| Table 3: List of the relevant DOD Processes and Services..... | 17 |
| Table 4: List of the relevant DOD Requirements [5]..... | 17 |
| Table 5: Enhanced Slot-Swapping summary..... | 72 |
| Table 6: UDPP Departure summary. | 78 |
| Table 7: Main enhanced Slot-swap operational differences. | 82 |
| Table 8: Main UDPP departure operational differences | 82 |
| Table 9: Information exchange requirements for OI steps AUO-0101-A and AUO-0103-A..... | 128 |

List of figures

| | |
|--|-----|
| Figure 1: The ‘apply and monitor the UDPP process’, from the DOD..... | 25 |
| Figure 2: CTOT allocation process..... | 29 |
| Figure 3: ETFMS Slot list for a regulation. | 32 |
| Figure 4: ETFMS: Regulation editor..... | 33 |
| Figure 5: slot-swapping principle. | 35 |
| Figure 6: ATFM slot-swap example..... | 36 |
| Figure 7: Network Impact display window. | 38 |
| Figure 8: Trajectory of a flight impacted by several regulations. | 38 |
| Figure 9: Impact of a slot-swap into the several slot Sequences along the route of the flight | 39 |
| Figure 10: Example: Entry counts in REG-1 before the slot-swap..... | 39 |
| Figure 11: Example: Entry counts in REG-1 after the slot-swap: HOP225 is forced as an overload into an earlier slot | 40 |
| Figure 12: Example: Safety calculation of overload slot on Entry counts in REG-1 after the slot-swap. . | 40 |
| Figure 13: A-CDM Logical elements. | 43 |
| Figure 14: Principle of the Pre-Departure Sequence calculation. | 45 |
| Figure 15: A break-down of a typical year for London Heathrow. | 46 |
| Figure 16: A-CDM DPI timescale | 47 |
| Figure 17: Paris Charles de Gaulle’s (CDG’s) CDM case..... | 48 |
| Figure 18: UDPP System Architecture | 54 |
| Figure 19: Slot allocation system..... | 55 |
| Figure 20: Metaphor for UDPP. | 56 |
| Figure 21: Introduction to a regulation’s reference time list. | 57 |
| Figure 22: Reference times are swapped. | 58 |
| Figure 23: TSATs for regulated, swapped flights. | 59 |
| Figure 24: Description of the Multi-swap of ATFM Slot Swap (‘Type 1’). | 64 |
| Figure 25: Description of the ‘Type 2’ multi-swap. | 65 |
| Figure 26: Principle of ATFM Slot Substitution on Cancellation..... | 67 |
| Figure 27: Principle of the Most Penalising Delay..... | 70 |
| Figure 28: Explanation of the UDPP Departure Concept..... | 73 |
| Figure 29: Principle of the Departure Reference-Time Reordering..... | 74 |
| Figure 30: Principle of the First Priority for Departure. | 75 |
| Figure 31: Upwards Cascade on Departure Cancellation..... | 77 |
| Figure 32: UDPP Step1 added flexibility. | 79 |
| Figure 33: Display of Occupancy Counts. | 84 |
| Figure 34: Use case 1: ATFM Slot Substitution on Cancellation. | 90 |
| Figure 35: Use Case 2: Multi-swap of ATFM Slot Swap. | 95 |
| Figure 36: Use Case 3: Pre-allocated ATFM slot-swap. | 100 |
| Figure 37: Use Case 4: ATFM Most Penalising Delay..... | 105 |
| Figure 38: Use Case 5: Departure Reference-Time Reordering..... | 109 |
| Figure 39: Use Case 5: an AU example of Departure Reference-Time Reordering..... | 110 |
| Figure 40: Use Case 6: First Priority for Departure. | 114 |
| Figure 41: Use Case 7: PDS Ownership on cancellation..... | 118 |
| Figure 42: Explaining the notation of a requirement’s identifier. | 124 |

founding members

founding members



Avenue de Cortenbergh 100 | B -1000 Bruxelles
www.sesarju.eu

Executive Summary

Long in advance, Airspace Users (AUs) schedule their flights to match their commercial strategy. But on Medium/Short Term Planning or Execution operations, high Demand Capacity Imbalance situations generate delay that impact Airspace Users operations. Sometimes delay is such that AUs have to cancel some of their flights.

However, from an AU point of view, all flights are not equal: some are fully booked whereas others aren't; some transport connecting passengers, some are important to get on time to respect IATA airport slot punctuality, etc. Unfortunately, the AUs have very few means to react on disrupted situations delays and "choose" which flight they would like to get least/most impacted.

The UDPP (User Driven Prioritisation Process) aims to provide Airspace Users the possibility to play a role and keep their business priorities on track when operations are disrupted. UDPP will ensure that within the capacity limitations given, the maximum usage of the available capacity is being used, while taking Airspace User priorities into account.

By giving the Airspace Users the opportunity to prioritize their flights, the benefit obtained with UDPP can be summarized as

- reducing the inefficiency caused by primary delay and reactionary delay of Airspace User operations, and
- reducing the cancellation-induced cost for passenger compensation, both direct (paying the passenger) as well as indirect (rerouting, lodging, etc.).

UDPP-step1 provides AUs more opportunities and flexibility to rearrange their flight sequences by prioritising, swapping, or reordering.

Two SESAR solutions are supported by this OSED: Enhanced ATFM Slot Swapping (solution #56), and UDPP Departure (solution #57).

On en-route congestion, the existing air traffic flow management (ATFM) slot-swap is extended to allow an enhanced service, providing a wider range of possibilities and increased flexibility.

On departure, the AUs priority demands will be taken into account and processed into the pre-departure sequence. UDPP is in essence a collaborative decision making (CDM)-based process, all stakeholders contribute to the decision making process that ultimately produces a pre-departure sequence, respecting the Business Interest of the Airspace User. Departure swapping is not just available during times of capacity constraint at the departure airport, but is also available for flights that have accumulated their own delays in the absence of any network or airport delay.

As UDPP is designed to be a means for Airspace Users to prioritize their important flights in case of critical situations, it could become a key and powerful process for airspace users to reduce the delay/cancellation induced cost. It is a reality that the Airspace Users manage their operations in a competitive context; however UDPP should not be used by one Airspace User to the detriment of any other AU. To ensure fairness and equity in the prioritisation process, UDPP will include a set of principles and rules.

founding members



Avenue de Cortenbergh 100 | B -1000 Bruxelles
www.sesarju.eu

1 Introduction

1.1 Purpose of the document

The document is the **final version** of the Operational Service and Environment Definition (OSED) for the User Driven Prioritisation Process (UDPP) concept in SESAR Step 1. All validation activities have ceased, and this document has been updated where necessary to take account of the findings from the validation process.

The OSED is used as the basis for assessing and establishing operational, safety, performance and interoperability requirements for the related systems further detailed in the Safety and Performance Requirements (SPR) document. The OSED identifies the operational services supported by several entities within the ATM community and includes the operational expectations of the related systems.

1.2 Scope

The OSED document details the operational concept, which is described at a higher level in the Detailed Operational Description (DOD) [5] in the scope of its Operational Focus Area (OFA). It defines the operational services, their environment, use cases and requirements.

| Operational Package | Operational Sub-package | Operational Focus |
|--|--|---|
| PAC05 Integrated and Collaborative Network Management | Demand and Capacity Balancing En-route | Airspace Management and AFUA |
| | | Dynamic Sectorisation and Constraint Management |
| | | Enhanced ATFCM Processes |
| | | Network Operations Plan |
| | | UDPP (OFA05.03.06) |

Step 1 is a transition from IP1 including operational improvements implemented in the context of DMEAN. UDPP will be first used to address reduced airports capacity, with a primary focus on departure congestion (local demand management). The collaborative decision making process will mainly rely on the existing system (TTOT and ATFM Slot Swapping) using current techniques adapted to SWIM-compliant information sharing.

The present OSED Step1 refines the processes and services (DOD elements) identified by SWP07.02 as described in the DOD [5]:

| Diagram | Node | Process | Code | Description | Associated Use Case |
|--|--------------------|------------------------------------|------|---|---------------------|
| Balance Demand with Resources & Capabilities (D) | Network Management | Apply and monitor the UDPP process | D60 | The Network Management Function identifies the need for a UDPP process, identifies the partners to be involved and initiates the process. In case a UDPP process is activated, the NM facilitates its implementation by assessing the impact on the network. | UC-NP-27/28/29 |

The OSED captures expected performance in accordance with the performance framework (B.4.1), and develops scenarios and use cases.

The OSED defines the Operational Requirements, based on the expected performance, scenarios and use cases.

The UDPP concept is embodied by these two OI Steps:

- AUO-0101-A Enhanced ATFM Slot Swapping;
- AUO-0103 UDPP Departure.

1.3 Intended readership

The intended audience for this OSED is:

- SESAR project 07.06.02 members;
- P06.02-P06.05: Co-ordination and consolidation of concept definition and validation (Airport) ; coordination is required between the two x.2 projects considering the harmonisation of Airport and Network Planning (e.g. consolidation of AOP and NOP, multiple flight trajectory, UDPP/CDM etc.)
- SWP11.1: FOC/WOC supporting methods and tools project, for the evolution of the Airlines Operations Centres' systems
- SWP07.02: for consolidation at Network Operations level,
- WP8 for data modelling

Airspace Users, ANSP, airport and NM are essential stakeholders of the project. They are represented either in the project team or (for ANSP) through the SWP07.02.

1.4 Structure of the document

The structure of this OSED is as follows:

1. The INTRODUCTION gives a general description of the document, including the purpose, scope, audience and background.
2. The SUMMARY OF OPERATIONAL CONCEPT FROM DOD [5] provides a general description of the operational concept in line with the DOD. It addresses the background, the problem statement, the definition of the Operational concept, the expected benefits, the elements of the Operational Concept, and issues such as fairness and equity.
3. The DETAILED OPERATING METHOD states the current operations as the Previous Operating Method, provides a description of the New SESAR Operating Method, with a comparison explaining the differences and evolutions in systems and tools. The New Operating Method is split between the 2 OI Steps covered by this OSED : Enhanced ATFM Slot Swapping and UDPP Departure.
4. The DETAILED OPERATIONAL ENVIRONMENT addresses the Operational Characteristics, the Roles and Responsibilities, and the Constraints.
5. The USE CASES describe the Operational Scenarios and associated Use Cases, providing a step description of the processes and services in nominal and non-nominal situations:

founding members



Avenue de Cortenbergh 100 | B -1000 Bruxelles
www.sesarju.eu

- The 4 first Scenarios describe the features included in the OI Step AUO-0101-A - Enhanced ATFM Slot Swapping.
 - The others describe the features included in the OI Step AUO-0103 - UDPP Departure.
6. The REQUIREMENTS describe the functional or qualitative requirements applicable to the operational processes.

The APPENDIX A provides justifications, and the APPENDIX B gives new information elements.

This template is adapted from EUROCAE ED-78A [6].

1.5 Background

During the SESAR Definition Phase when DCB, Demand Capacity Balancing, came to being, the Airspace Users involved noticed that DCB without any role for the Airspace User would be unbalanced from their perspective. For that reason UDPP, User Driven Priority Process, became part of the balancing equation. UDPP will play its part during capacity shortage situations, although initially designed for high Demand Capacity Imbalance situations; it could bring added benefit in network nominal conditions as well.

As stated in the “SESAR Concept of Operations at a Glance” [9], UDPP is defined as “A process during periods of reduced capacity in which the service provider declares the available capacity and users, interacting collaboratively and collectively with the provider, propose specific flights to fill it”. The major principle behind UDPP is that “In UDPP, airspace users among themselves can request a priority order for flights affected by delays caused by an unexpected reduction of capacity, which is then communicated to the Network Management function. Users may trade flexibility in one dimension for another”.

The UDPP project 07.06.04¹ Initiation Report (23/02/2011) indicates that this process is needed in case of disruptions of the network and at congested airports. The process covers exchanges within and between Airspace Users and will leave room for Airspace Users to exchange and or swap slots if they individually agree to do so. It builds on A-CDM concept for non-regulated flights and extends the scope of the existing ATFM Slot Swapping procedure for regulated flights.

The UDPP process will be based on agreements and rules that are transparent to the other actors but that respect principles agreed by all parties.

Capacity shortage situations:

During the SESAR Definition Phase when Demand Capacity Balancing (DCB) came to being, the Airspace Users involved noticed that DCB without any role for the Airspace User would be unbalanced from their perspective. For that reason UDPP, User Driven Priority Process, became part of the balancing equation. UDPP will play its part mainly during capacity shortage situations.

Activation of UDPP:

Although initially described for high Demand Capacity Imbalance situations in the Initiation Report, AUs realized that UDPP could bring added benefit in small delays conditions as well. Even if the traffic situation is almost fluid at network level, it could occur that an Airspace User experiences a need of using the UDPP processes.

The fact that UDPP will be active continuously, i.e. that UDPP is functional under all circumstances, has been identified as a business need of Airspace Users.

Triggering of a UDPP process:

¹ The UDPP project was initially launched as project 07.06.04, but in 2013/2014 became part of project 07.06.02.

To respond more widely to Airspace Users needs, it has been agreed in STEP-1, that the opportunity to apply the UDPP processes could be triggered at any time on Airspace User request if need is identified.

UDPP Step-1 is focused on Short Term Planning phase of a flight. UDPP Step 2 will address the process by which Airspace Users have the ability to prioritise flights upstream if they wish so, so that congestion measures can proactively take Airspace Users' preferences when allocating delays and/or STAM (Short-Term ATFCM Measures).

1.6 Glossary of terms

This section identifies terms not covered in one or more referenced documents and a proposed definition.

Abbreviations and acronyms are currently used in this document. In the ATM language, it happens that some acronyms may have several meanings:

- a) AO may stand for: Aircraft Operator; Airlines Operator; Arrival Operations; ATM Operations; Airport Operations.
- b) AU may stand for: Airspace User; Access Unit; Arbitrary Unit; Administrative Unit; Air Navigation Unit.

In this document, any reference to AO is meaning Aircraft Operator; and any reference to AU is meaning Airspace User.

- c) F/WOC: FOC (Flight Operations Centre) replaces the previous AOC (Airline Operations Centre). WOC stands for Wing Operations Centre and addresses military operations.

1.7 Abbreviations, Acronyms and Terminology

| Term | Definition |
|---------------|--|
| A-CDM | Airport Collaborative Decision Making |
| ADD | Architecture Definition Document |
| ANSP | Air Navigation Service Provider |
| AO | Aircraft Operator |
| AOC | Airline Operations Centre |
| AOP | Airport operations plan |
| APT | Airport |
| ATFM | Air traffic flow management |
| ATM | Air Traffic Management |
| AU | Airspace User |
| CASA | Computer Aided Slot Algorithm |
| CC | Capacity Constraint |
| CDM | Collaborative Decision Making |
| CFMU | Central Flow Management Unit (now called the 'Network Manager') |
| CONOPS | Concept of Operations |
| CTO | For the Network Manager, CTO stands for Calculated Time Over. It is the time used for calculating the CTOT for a regulated flight. In ConOps Steps CTO stands for Controlled Time Over. In this document, and more particularly in the chapter 3-Detailed Operating Method, CTO refers to the current operations meaning used by the Network |

founding members



| Term | Definition |
|---------------------------|--|
| | Manager: Calculated Time Over. |
| CTOT | Calculated Take-Off Time |
| DCB | Demand capacity balancing |
| DPI | Departure planning information (a message) |
| DOD | Detailed Operational Description |
| E-ATMS | European Air Traffic Management System |
| EOBT | Estimated Off-Block Time |
| eSS / ESS | Enhanced slot swapping |
| ETFMS | Enhanced Tactical Flow Management System |
| EVS | Equipment Visibility System |
| FMP | Flow management position |
| FOB | Fixed Based Operators |
| FOC | Flight Operations Centre |
| FPFS | First planned first served |
| HUD | Heads-Up Display the projection of readings from instruments onto a windscreen, enabling an aircraft pilot or car driver to see them without looking down |
| INTEROP | Interoperability Requirements |
| IRS | Interface Requirements Specification |
| LVP | Low Visibility Procedure |
| MPR | Most penalizing regulation |
| NMF | Network Management Function |
| NMOC | Network Manager operations centre |
| NOP | Network operations plan |
| OCD | Operational Concept Description |
| OFA | Operational Focus Areas |
| OSED | Operational Service and Environment Definition |
| PDS | Pre-Departure Sequence |
| SESAR | Single European Sky ATM Research Programme |
| SESAR Programme | The programme which defines the Research and Development activities and Projects for the SJU. |
| SJU | SESAR Joint Undertaking (Agency of the European Commission) |
| SJU Work Programme | The programme which addresses all activities of the SESAR Joint Undertaking Agency. |
| SOBT | Scheduled Off-Block Time |
| STAM | Short-Term ATFCM Measures |
| SPR | Safety and Performance Requirements |
| TAD | Technical Architecture Description |
| TTO | Target Time Over |
| TTOT | Target Take-Off Time |
| TS | Technical Specification |
| TV | Traffic Volume |
| TSAT | Target Start-up Time |
| UDPP | User Driven Prioritisation Process |
| WOC | Wing Operations Centre |

founding members



Avenue de Cortenbergh 100 | B -1000 Bruxelles
www.sesarju.eu

founding members



Avenue de Cortenbergh 100 | B -1000 Bruxelles
www.sesarju.eu

2 Summary of Operational Concept from DOD

This section addresses WHAT is to be developed and provides the traceability to the relevant WP7 Network Operations DOD [5]. It details in simple terms and plain language the operational concept in the scope of the Operational Focus Area UDPP.

2.1 Mapping tables

This section contains the link with the relevant DOD [5], scenarios and use cases, environment, processes and services relevant for this particular OSED.

The following tables are coherent with the related DOD Ops 07.02 [5]: iterations with OPS 07.02 may be necessary in relation with the consolidation activities.

Table 1 lists the Operational Improvement steps from Integrated Roadmap Dataset 14 [10] that are relevant to UDPP.

| OI Step | OFA | Step | Master or Contributing | Description and Rationale |
|---|------|--------|------------------------|---|
| AUO-0101-A Enhanced ATFM Slot Swapping | UDPP | Step 1 | Master | <p>Description: The swapping of regulated flights on departure, on arrival, and en-route, that is already possible for the flights of the same Airspace User (AU) sharing the same Most Penalising Regulation (MPR), will be extended to all regulated flights without any constraints due to AU (or MPR if possible). Changing of flight priority between 2 flights where at least one flight is not regulated will also be possible. The AUs requests for these changes in flight priority will be introduced at the initiative of the AUs themselves, of the airport authorities or of the Network Management function. The Network Management function will supervise the swapping or changing of flight priority requests.</p> <p>Rationale: A more flexible management of flights that are subject to regulations, especially during an airport critical event, and more freedom of choice for AUs to adapt their operations.</p> |
| AUO-0103 UDPP Departure | UDPP | Step 1 | Master | <p>Description: CDM airports will allow the Airspace Users to change among themselves (via the pre-departure management process) the priority order of flights in the pre-departure sequence.</p> <p>Rationale: The departure time will be automatically communicated/coordinated with the Network Management Function (NMF) via the DPI message as described in the A-CDM concept.</p> |

Table 1: List of relevant OIs within the OFA UDPP.

Table 2 identifies the link with the applicable scenarios and use cases of the DOD [5]. See also, wait for it, section 4.2.2.1.2.2.3.2 in the DOD.

| Scenario identification | Use Case Identification | Reference to DOD section where it is described |
|----------------------------|---|--|
| Medium/Short Term Planning | UC-NP-27 Airspace user proposes exchange of ATFM slot and/or departure time | §7.3.2. Allocation of Scenarios [5] |
| | UC-NP-28 NMF/Airport verifies the UDPP proposal | |
| | UC-NP-29 NMF/Airport approves and publishes the UDPP proposal | |

Table 2: List of relevant DOD Scenarios and Use Cases.

In Section 5 of this document, the Medium/Short Term Planning Scenario from the DOD has been refined into sub-scenarios, matching the processes and services developed in the UDPP Step-1.

Table 3 identifies the link with the applicable Operational Processes and Services defined in the DOD.

| DOD Process / Service Title | Process/ Service identification | Process/ Service short description | Reference to DOD section where it is described |
|-------------------------------------|---------------------------------|---|--|
| Apply and monitor the UDPP process | D60 | The Network Management Function identifies the need for a UDPP process, identifies the partners to be involved and initiates the process. In case a UDPP process is activated, the NM facilitates its implementation by assessing the impact on the network. | §5.3 [5]. Balance Demand with Resources & Capabilities |
| No Services identified in DOD 07.02 | | | |

Table 3: List of the relevant DOD Processes and Services

Table 4 summarizes the Requirements including Performance (KPA related) requirements This table supports defining the performance objectives in the scope of the addressed OFA. The DOD performance requirements are structured to respond to Key Performance Indicators (KPIs) targets / decomposed KPIs, so this table will support traceability to the performance framework.

| DOD Requirement Identification | DOD requirement title | DOD requirement description | Reference to DOD section where it is described |
|--------------------------------|-----------------------|---|--|
| REQ-07.02-DOD-0001.0009 | Operations | Airspace Users among themselves can recommend to the Flow or Network Management a priority order for flights. | §6.1 |

Table 4: List of the relevant DOD Requirements [5].

2.2 Operational Concept Description

2.2.1 Operational Concept Definition:

When demand for air traffic services is expected to exceed the available capacity of airports or airspace within the ECAC area, the Network Manager issues slot times to balance demand with capacity on a First-Planned-First-Served (FPFS) basis. This process does not take into account Airspace Users' preferences.

From the Airspace Users' perspective, flights are not equal: various criteria may have an impact on the need of punctuality (connecting passengers, curfew at Destination Airport, crew duty time limits, rerouting possibilities or hotel booking for delayed passengers, EU261, presence of unaccompanied children or disabled passengers, technical constraint on the aircraft, state subsidized line, next rotation leg, etc.). To improve their operational efficiency, Airspace Users wish to have a customized service taking into consideration their high priorities.

To help airspace users manage their flights when they are subject to delay, a user driven prioritization process has been designed as part of the SESAR programme.

Definition summary:

UDPP is designed to be a means for Airspace Users to prioritize their important flights in case of critical situation. The aim of UDPP Step1 is to provide AUs the possibility to re-arrange their own flight sequences through an AU-driven prioritisation process. The UDPP Step1 process includes the following:

- *UDPP departure: on A-CDM airports and non A-CDM airports supporting pre-departure sequencing allow the Airspace Users to change among themselves and via the airport authorities the priority order of flights, in the pre-departure sequence. Provisions will be introduced in NM to take into consideration the CDM airport delay.*
- **ATFM Slot Swapping Enhancement:** the current slot-swapping of regulated flights between AUs with commercial agreements on departure, on arrival, and en-route, are extended to allow an enhanced service, providing a wider range of possibilities and increased flexibility. The enhanced Slot-Swapping (eSS) will include the development of new processes and services addressing multi ATFM slot-swapping, and the possibility to swap a pre-allocated ATFM slot with an issued ATFM slot of regulated flights.

Although UDPP allows AUs to prioritise their own flights (within existing commercial agreements), AUs may negotiate between themselves, subject to final agreement of all actors. As UDPP should not be used by one Airspace User to the detriment of any other AU, UDPP will include a set of principles and rules to ensure fairness and equity in the prioritisation process.

For ATFM slot swapping, UDPP is designed to be operated in case of capacity constraints. For departure swapping, swapping is available anytime and therefore could also include flights that have accumulated their own delays in the absence of any network or airport delay. The UDPP process is foreseen to be initiated by AUs, and supported by the Network Management Function/ APT; the prioritisation decision will be the result of a collaborative process involving all actors (Airspace Users, Network Management, Airports, Flow managers, Air Traffic control).

In addition to the notion of an individual AU acting internally its operations for its own benefit, the notion of the AU community accepting some changes for the “common good” may be addressed through a preliminary trade-off between Airspace Users among themselves.

The UDPP project team members representative of Airspace Users wish to highlight that UDPP is one of the most important processes where AU will be able to gain most from SESAR. In this view, UDPP should be further developed later-on in both planning and execution phase for departure, en-route and arrival.

2.2.2 Background:

In order to be competitive in the global aviation environment, network airlines can distinguish themselves from other airlines by providing a high quality product (in terms of reliability, transfer connectivity, punctuality, etc.) at a competitive price. The basic idea is to connect a multitude of destinations via a single (or multiple) airport(s), thus establishing a number of city-pair connections that exceeds the number of actual flights that are flown. The consequence of this “hub and spoke” operation, which includes planned minimisation of aircraft downtime and passenger connect time, is a concentration of flights during peak hours.

From the perspective of Air Traffic Management (ATM), all flights are equally important, unless an aircraft requires priority handling due to an emergency or unless an aircraft has a special status. This equality of flights is reflected in the current ATM operational concept of handling air traffic.

When demand for air traffic services is expected to exceed the available capacity of airports or airspace within the ECAC area, the Network Manager issues ATFM slots to balance demand with capacity on a First-Planned-First-Scheduled basis. This process does not take into account Airspace Users' priorities.

At CDM airports, the CDM manages the Demand/Capacity imbalance using pre-departure sequence tools that allocate departure delays. Those systems don't take into account Airspace Users' priorities either.

2.2.3 The problem statement:

However, from the aircraft operator perspective, not all flights are equal. One of the key issues for large hub carriers is the optimization of connecting flights for their passengers. A hub carrier offers to customers an increased capability to manage flights connections. When operations are disrupted (e.g. during situations when traffic demand exceeds the available capacity), connections via the hub-airport may not be possible and the airline's transfer product is lost or reduced in quality. In addition to missed passenger connections, crew and/or aircraft may also not be available in time for the next flight. Besides direct economic impact, long-term passenger satisfaction is negatively impacted, which also has a long-term impact on the airline competitiveness. In a similar way, a lot of criteria, important for all types of airspace users overall performance, are not currently taken into account by the system, such as:

- Flight mileage (long range/short range)
- Number of passengers
- Connections (intra AUs, inter AUs, long haul, short haul)
- Curfew
- Flight duty/time limitations (FTL)
- Number of flights departing from the airport

- “Airport Slot”² (coordinated airports)
- Fuel and CO₂
- Aircraft Maintenance issue
- Aircraft availability/positioning
- Airlines strategic/ political decisions

To take into account their constraints the airlines wish to distinguish between flights with and flights without priority: during disruptions, the flights with a higher value would be handled with priority, but the FPFS principle currently prevents ATC from changing the departure sequence for airline priority reasons. This shortcoming of operations resulted in the basic requirement for slot swapping techniques.

The current ATFM slot swapping between regulated flights

A first step to better respond to users needs already exists today, through **ATFM slot swapping**. This functionality is however limited to swaps only between flights within a Group that share the same Most Penalizing Regulation through FMPs (see the ATFCM Operations Manual [11]. Today there are almost no departure regulations (ATFM slots) set at Network level anymore, but a number of regulations are set to manage Arrival traffic. In this context, an airport can be the Most Penalizing Regulation.

2.2.4 The Operational Concept basics

UDPP is the Airspace User Driven Process that contributes to resolving a Capacity Constrained situation, either at Airport or in Airspace. Initially UDPP will limit itself to resolve Airport Capacity Shortage situations, at a later stage UDPP will also be involved in resolving the effect of Airspace Constraints. Through UDPP Airspace Users will have an opportunity to prioritize their flight(s) in a Capacity Constrained situation, such that the 'damage' of these situations can be better controlled and thus more efficiently dealt with. The improved efficiency and the associated reduction of dis-benefit are the added value areas of UDPP.

2.2.4.1 The Operational Concept Environment:

The UDPP Step-1 aims to provide Airspace Users more possibilities and flexibility in their operations once a sequence has been defined to enter a congested area. On En-route and Arrival congested areas, the sequence and associated delays is calculated by the Network Manager. On Departure CDM Airports, the sequence is defined by the CDM. The UDPP Step-1 addresses those two configurations as follows:

a) ATFM Slot Swapping Enhancement:

The current slot-swapping of regulated flights between AUs with commercial agreements on departure, on arrival, and en-route, will be extended to allow an enhanced service, providing a wider range of possibilities and increased flexibility. The enhanced Slot-Swapping (eSS) will include the development of new processes and services addressing multi ATFM slot-swapping, and the possibility to swap a pre-allocated ATFM slot with an issued ATFM slot of regulated flights.

The Network Management function will supervise the acceptance of ATFM slot-swapping requests.

b) UDPP – Departure:

² In this document, to avoid confusion, the terms “airport slots” and “ATFCM slots” will be used to distinguish between the strategic slots of the Scheduling Committees for coordinated airports, on the one hand, and the slots allocated by the Network Manager in case of a tactical regulation on the other hand.

A-CDM airports and non A-CDM airports supporting pre-departure sequencing will allow the Airspace Users to change among themselves and via the airport authorities the priority order of flights, in the pre-departure sequence. This will possibly bring flexibility to the pre-departure sequence reordering of ATFM regulated flights. Changes in the pre-departure sequence will be communicated to the Network Management function. Provisions will be introduced in NM to take into consideration the CDM airport delay.

To address fairness and equity, the UDPP process will be based on agreements and rules that are transparent to the other actors but that respect principles agreed by all parties.

The objective of UDPP-Step1 is a more flexible management of departure sequence especially during a critical event, and more freedom of choice for airspace users to adapt their operations. In this perspective, UDPP Step 1 addresses not only **exchanges** but also flight **cancellation** and **substitution** on the day of operation (D day).

2.2.4.2 UDPP-Departure, a CDM-like Process

In SESAR Step 1, UDPP covers the exchange of flights departing from a congested airport at the request of Airspace Users when there is a capacity shortfall. Because the airports more prone to congestion -where UDPP will provide the most benefits- are likely to become CDM-airports in the future, UDPP-Step 1 has been developed with CDM-airports in mind.

UDPP-Departure is a typical CDM-based process, all stakeholders including Airspace Users will contribute to finding the best possible solution in a Capacity Constrained situation. In this case UDPP will help to minimize the effects of the Capacity Constrained situation by minimizing the knock-on & reactionary effects of severely delayed or even cancelled flights for passengers and freight and the Airspace Operator.

In the existing CDM process, UDPP-Departure has clearly the mission to create a CONTEXT where a specific AU can handle his own interests within the constraint itself. UDPP is though a “facilitator” and it can be assumed that UDPP-Departure will contribute to building a local Pre-Departure Sequence taking AU-priorities into account.

It can be assumed that the local (A-CDM) process builds a Pre-Departure Sequence taking both Airport and Network Constraints into account to assess available Capacity. This Capacity Solution will be an input to the AU-own Priority Process and will be used by the AU to expand the AU-Demand with the attribute "User Priority" to feed a “UDPP context” on any specific given airport. Depending on the significance/severity of the Capacity Constraint in relation to the AU's original schedule, the AU will have the possibility to modulate its schedule by e.g. prioritizing and in worst case cancelling flights.

2.2.4.3 UDPP Step-1: a capacity constraint reactive process

A Capacity Constraint (CC) is when a Demand/Capacity imbalance has been identified in a specific area and for a specific duration. It is acted on at NM level in publishing a regulation for a specific Traffic Volume and for a specific time window, and results in the issuance of an ATFM Slot sequence list. At CDM airport level, Capacity Constraints lead to the allocation of delay for the departure times (TTOT: Target Take-Off Time and associated TSAT: Target Start-Up Time) reflected in the Pre-Departure Sequence.

UDPP will give the Airspace Users the possibility to request a revision to the sequence (either ATFM slot list or Airport Pre-Departure Sequence), based on their operational priorities.

The UDPP Step-1 is a reactive process: the features and processes developed in this phase will only be applicable when a sequence is being determined as explained above. The “ATFM Slot Swapping Enhancement” and the “UDPP-Departure” determine a set of new functionalities that will bring more

founding members



Avenue de Cortenbergh 100 | B -1000 Bruxelles
www.sesarju.eu

possibilities and flexibility for AUs to eventually react to current Demand/Capacity management procedures.

Pro-active measures are foreseen in the UDPP Step-2.

2.2.4.4 Timeline of Airspace User Priorities

Nowadays, all events that potentially influence or disturb the AU-schedule are being considered and a revised schedule is being generated. Flight cancellation and flight delay clearly are the payload (Passenger & Freight) consequences of rebuilding the schedule.

It can be foreseen that AU-internal Prioritization will converge close to instant of operation: D0 (zero).

2.2.4.5 UDPP Actors' roles and participation in UDPP Step 1

a) Airspace User

He is responsible for the monitoring and the assessment of the level of deterioration of his flights operations, and for triggering the UDPP process.

Participation of Airspace Users in UDPP is on a voluntary basis. Through UDPP, AU's will have an opportunity to provide Prioritization requests to improve their flight operations.

b) Network Manager

NM has no role in the identification and initiation of the UDPP process. It plays a major role in the development and implementation of the "ATFM Slot Swapping Enhancement". It is informed of changes resulting from the development and implementation of the "UDPP-Departure".

c) Airport CDM

Airport CDM has no role in the identification and initiation of the UDPP process. It plays a major role in the development and implementation of the "UDPP-Departure". It is informed of changes resulting from the development and implementation of the "ATFM Slot Swapping Enhancement".

2.2.5 UDPP principles

UDPP is designed to be a means for Airspace Users to prioritize their important flights in case of a delay situation. It is a reality that the Airspace Users manage their operations in a competitive context. UDPP should not be used by one Airspace User to the detriment of any other AU.

To ensure fairness and equity the UDPP Step-1 Concept is built on current ATFM Slot-Swapping rules already in current operations. The UDPP project has defined a number of further detailed principles and rules to be applied for Step 2. The latest version of these principles is available in Appendix A, and comes from the Step 2 OSED [7]. Whilst discussions to define what may be equitable or not have not happened for Step 1, the principles and rules identified for Step 2 may serve as a guide. The validation report for Step 1 recommends that "The UDPP project should (re)discuss and agree the principles of UDPP, and then based on these principles should define clear, unambiguous rules to be able to decide what is equitable or not" [12].

2.2.5.1 Current ATFM Slot-Swapping principles and rules

The following describes the fairness and equity principles and rules applying to the current ATFM Slot-swapping process.

1. The Flight list and allocated CTOTs are displayed on the NOP and CHMI, and visible by all.
2. The ATFM Slot-swapping process and infrastructure is easily and readily accessible to all actors.

founding members



Avenue de Cortenbergh 100 | B -1000 Bruxelles
www.sesarju.eu

3. When an ATFM Slot-swapping is requested by an Airspace User, the Impact on the Network Assessment processed by NM ensures that there shall be no negative impact on the network before the Slot-swap being accepted.
4. Before an ATFM slot-swap of two flights operated by different Airspace Users is triggered, there must be binding agreements between the AUs involved.
5. AUs have the right not to request any slot-swap without prejudice in the Flights Sequence.
6. When a Slot-swapping request is made by an Airspace User, NM shall provide a response.
7. The slot-swapping requests and responses are made available to AU's on the NOP e-Helpdesk.
8. The slot-swapping requests are recorded to allow for post-operations tracking of potential abuse or cheating.

2.2.5.2 UDPP Step-1 Principles and Rules

As the AUO-0101-A Enhanced ATFM Slot Swapping is an extension of the current ATFM Slot-swapping process, aiming to provide more flexibility and re-prioritising opportunities, it stands to reason to apply the same set of rules and principles to the new operational processes.

The AUO-0103 UDPP Departure is a set of processes allowing flights exchanges in the CDM Airport Flights Sequence. Therefore, as the UDPP Departure concept is based on what already exists at NM level, the same rules and principles will also apply to the UDPP Departure processes.

1. The methodology and process of UDPP must at all times remain wholly transparent to all stakeholders.
2. The process and infrastructure will be easily and readily accessible, and be user-friendly to all actors.
3. When UDPP is used, it is currently assumed that there shall be no negative impact on the network.
4. Before UDPP is considered between AUs there must be binding agreements between the actors involved.
5. AUs have the right not to participate in UDPP without prejudice.
6. When a request for prioritisation is made, a response shall be required.
7. The UDPP process transactions information shall be made available to AU's by an automatic system.
8. The UDPP process transactions shall be recorded to allow for post-operations tracking of potential fraudulent tactics.

2.2.6 The UDPP Step1 Expected Benefits

Appendix C presents a description of the benefits as described in the interim version of the OSED (version 1.00, dated 30/04/2013).

Appendix D presents a set of seven benefit mechanisms, which represents the current best understanding of how the concept features impact performance.

2.3 Processes and Services (P&S)

This section refers to section 5 of the DOD [5]. The purpose of this section is to ensure coherence between federating and primary projects regarding the used P&S in the OFA.

founding members



Avenue de Cortenbergh 100 | B -1000 Bruxelles
www.sesarju.eu

2.3.1 Process PCS- 764 – DOD 07.02 Step1

There is only one Process identified in section five of the DOD [5] as part of the global Network process Dynamically Balance Network Capacity with Demand:

| | | | |
|------------------------------------|-----|---|---|
| Apply and monitor the UDPP process | D60 | The Network Management Function identifies the need for a UDPP process, identifies the partners to be involved and initiates the process. In case a UDPP process is activated, the NM facilitates its implementation by assessing the impact on the network. | §5.3 [5]. Balance Demand with Resources & Capabilities |
|------------------------------------|-----|---|---|

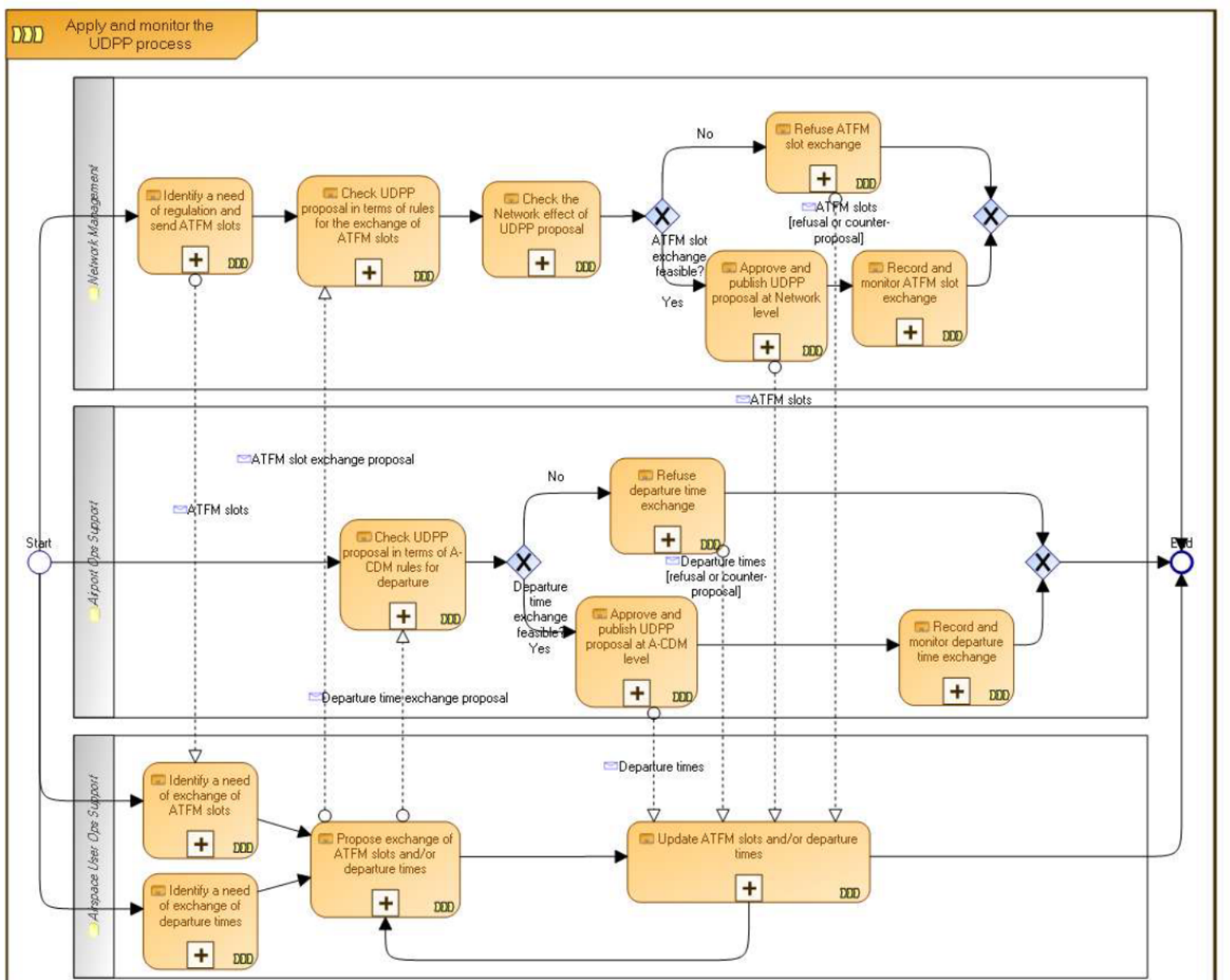

Figure 1: The 'apply and monitor the UDPP process', from the DOD.

Figure 1 shows processes for ATFM slot swapping (AUO-0101-A) *and* departure swapping (AUO-0103).

The processes shown in Figure 1 are not entirely correct. The errors are as follows: when refusing to accept an ATFM slot swap, the Network Manager does not make a counter proposal; similarly, the APOC does not make a counter proposal if the departure time exchange is unacceptable. SWP07.02 is now aware of the need to update the process diagram.

2.3.2 No Service identified in DOD 07.02 Step 1

There is no Service identified in the Network DOD 07.02 for UDPP Step 1 [5].

3 Detailed Operating Method

3.1 Previous Operating Method

The perspective from which UDPP step 1 will be developed stems from both the ATFM environment and the airport-CDM environment. These current operational environments are recalled in this section.

To fully understand in which context the User Driven Prioritisation Process will be developed, it is important to have a good understanding of the prioritisation practices already operated.

At Network Manager Level, prioritisation practices are driven by formalized and validated procedures, providing Airspace Users a range of possibilities that they use depending on the improvement provided and feasibility in the specific situation. Although P07.06.02 Step 1 deals with Slot-swapping, it is interesting to know about the whole picture, e.g. the various options an Airspace User has to improve a delayed flight. At first, the AU will try to find a solution that doesn't impact another of his flights. If unsuccessful, the slot-swapping process is seen as a useful process when no other solution has been found. But the actual range of possibilities to use it is very low.

At A-CDM level, means to accommodate prioritisation requested by AU aren't homogeneous. Most prioritisation practices are arranged on the phone on a case by case basis, in an informal way.

In this section, a description of the AU operating methods will also be provided. As AUs are meant to be the drivers of the UDPP process, it is important to understand their operating methods. Although AUs operations are very different from one to another, this section will try to give an overview of the main principles.

In a global view, the range of options, the complexity of constraints, and the workload of the various actors in degraded conditions are factors impacting the prioritisation processes.

3.1.1 NM Operating method

3.1.1.1 Capacity management at NM

3.1.1.1.1 NM Operations

NM Operations room is subdivided into different areas reflecting NM functions, such as: Medium/Short Term Planning; IFPS; Execution; ADS.

The Operations Room runs from 24h/24. Mission is to balance capacity against demand to operate a most efficient and safe traffic across ECAC geographical area.

The Execution team is composed of 9 controllers during day time. It deals with operational issues on day of operations. Operations are conducted in direct coordination with Flow Management Positions (FMPs), AUs, and other NM services (IFPS, Medium/Short Term Planning, ...).

A team of 7 Aircraft Operators Liaison Officers (AOLO) work from 6:00 to 22:00 try to find individual solutions (e.g. re-routing) for flights impacted by a high delay.

3.1.1.1.2 Traffic Volume capacity

a) Traffic Volume:

Traffic Volumes are defined by Flow Management Positions (FMP) and NMC. Each Traffic Volume is attached to a reference location. Reference locations are used to count the traffic load.

founding members



Avenue de Cortenbergh 100 | B -1000 Bruxelles
www.sesarju.eu

A reference location may be:

AS: Airspace

AD: Aerodrome

AZ: Group of aerodromes

SP: Specific Point

A Traffic Volume may be an ATC sector, but it can also be a specific traffic flow, crossing one or several ATC sectors. As many Traffic Volumes are defined as necessary.

For example, Athis-Mons FMP may raise a regulation on CDG Arrivals flow only to organise the landing sequence, leaving the rest of the traffic free from slot constraint.

Traffic Volumes regulations' delays are imputed to their reference location.

b) ATC ops-room flexibility:

ATC ops-rooms have a flexibility to adapt their global capacity to demand, to a certain extent. They may group / ungroup sectors, depending on the traffic prediction. When a grouped sector is overloaded, the first action is to ungroup it into unit-sectors, except in adverse situations such as strikes, where there is a lack of staff.

NM records the grouping/ ungrouping of ATC sectors on the ETFMS.

c) Traffic Volume capacity:

ATC sectors have a theoretical capacity window. The real capacity value is determined depending on various factors such as the type of traffic (mix of turbo-prop / jets), activation of military zones (less space for aircraft separation), etc.

d) Traffic load:

The NM calculation of the traffic load is a count of TV' entries, it doesn't take into consideration the time the aircraft will stay in the regulated traffic volume, nor the complexity of the flight profile.

e) Monitoring Value:

The monitoring value is a red line shown on the CHMI. It is set as an alert. If Traffic Volume load exceeds the Monitoring Value by 110%, NM calls the FMP to make sure they manage the situation. Most of the time (95%), the Monitoring Value equates the Traffic Volume capacity.

f) Occupancy:

The Occupancy value shows the load at instant "t". It takes into account the number of minutes an aircraft stays in the traffic volume. It also counts the aircraft a few minutes before physically entering the traffic volume, as the controller is already preparing its separation strategy.

The occupancy calculates the load based on the duration: real length of time the aircraft is in the traffic volume, plus the previous controller thinking. It provides a traffic picture closer to human workload.

3.1.1.1.3 Traffic Volume Regulation

One option when Demand is higher than Capacity is that a Regulation may be created. This may be at the initiative of NM, or on FMP request. Regulations are a way for FMPs to protect their airspace on safety perspective. It prevents from over-delivery situations.

a) Regulations publication:

Regulations are raised in execution phase and Medium/Short Term Planning phase. For very specific events (Olympic Games, 24h du Mans, etc.), regulations are defined in Strategic phase. Traffic Volumes regulations' delays are imputed to their reference location.

founding members



Avenue de Cortenbergh 100 | B -1000 Bruxelles
www.sesarju.eu

b) Regulations cancellation:

Before the FMP cancels a regulation, NM checks the impact on other FMPs, as it may impact their traffic load. Or it could happen that when cancelling an Arrival regulation, all flights waiting to depart at European airports suddenly get airborne, and there is a problem when they arrive at the previously restricted area.

To prevent this, for severely penalising regulations the regulation rate is increased by step up to nominal rate, then cancelled.

c) Regulations rate:

The regulation rate is the value taken as a reference for the Network Manager to count the traffic load and allocate ATFCM slots.

The regulation rate is not necessarily the same value as the Monitoring Value (red line).

d) Over-deliveries:

There is a tolerance for 10% traffic load exceed above the regulation rate. It is considered to be in an over-delivery status only when the traffic load gets above the 10% tolerance.

3.1.1.1.4 ATFCM SLOT Allocation Process

a) Slot definition:

Every 5 min, the NM system checks all received Flight Plans and DPI messages, and updates the FPL list. The CASA (Computer Assisted Slot Allocation) tool receives all Flight Plans and allocates automatically an ATFCM slot to any flight whose route filed in the FPL is detected to enter a regulated Traffic Volume (TV).

The ATFCM CTO (Calculated Time Over) is a specified time when the aircraft should enter the regulated traffic volume. In other words, CASA collects all entry demands, establishes the entry sequence for the regulated Traffic Volume, calculates the waiting time in the queue, and provides each candidate a ticket with a time to enter the regulated area (CTO: Calculated Time Over).

Then the departure time is calculated backwards based on the route filled in the flight plan, and the flight is allocated a Calculated Take-Off Time (CTOT). The CTOT is referenced to as the "ATFM slot" in common language.

b) Slot allocation rules:

ATFCM slots are only allocated to non-airborne flights, departing from an airport located in the ECAC area and some adjacent states.

c) Slot allocation calculation:

Based on the Estimated Off-Block Time (EOBT) filed in the FPL, the CASA system evaluates the time when the aircraft is going to enter the regulated Traffic Volume.

Taking this time as a reference, the CASA system looks for the first available slot for this aircraft to enter the regulated Traffic Volume. This available time is called the CTO (Calculated Time Over) and represents the Slot time for entering the regulated Traffic Volume.

Then the departure time is calculated back according to the filed route, and the Flight receives a CTOT (Calculated Take-Off Time).

If the available slot is found within [-5min/ +5min] of the Estimated Time Over (ETO); then the slot is considered "On-Time", and a zero delay CTOT is allocated.

d) Most Penalising Regulation:

If the FPL crosses several Regulated Traffic Volumes, then the system determines the Most Penalising Regulation (MPR), and the CTOT (Calculated Take-Off Time) is issued according to this MPR.

founding members



Avenue de Cortenbergh 100 | B -1000 Bruxelles
www.sesarju.eu

Only Traffic Volumes regulations are considered (departure, arrival, en-route); airport delays such as de-icing are not taken into consideration as an MPR.

e) Slot Sequence List:

To define the sequence of flights entering the Regulated Traffic Volume, CASA system is based on the "First Planned First Served" principle. This means that the EOBT (Estimated Off-Block Time) filed in the FPL is the data triggering the order in the slot list.

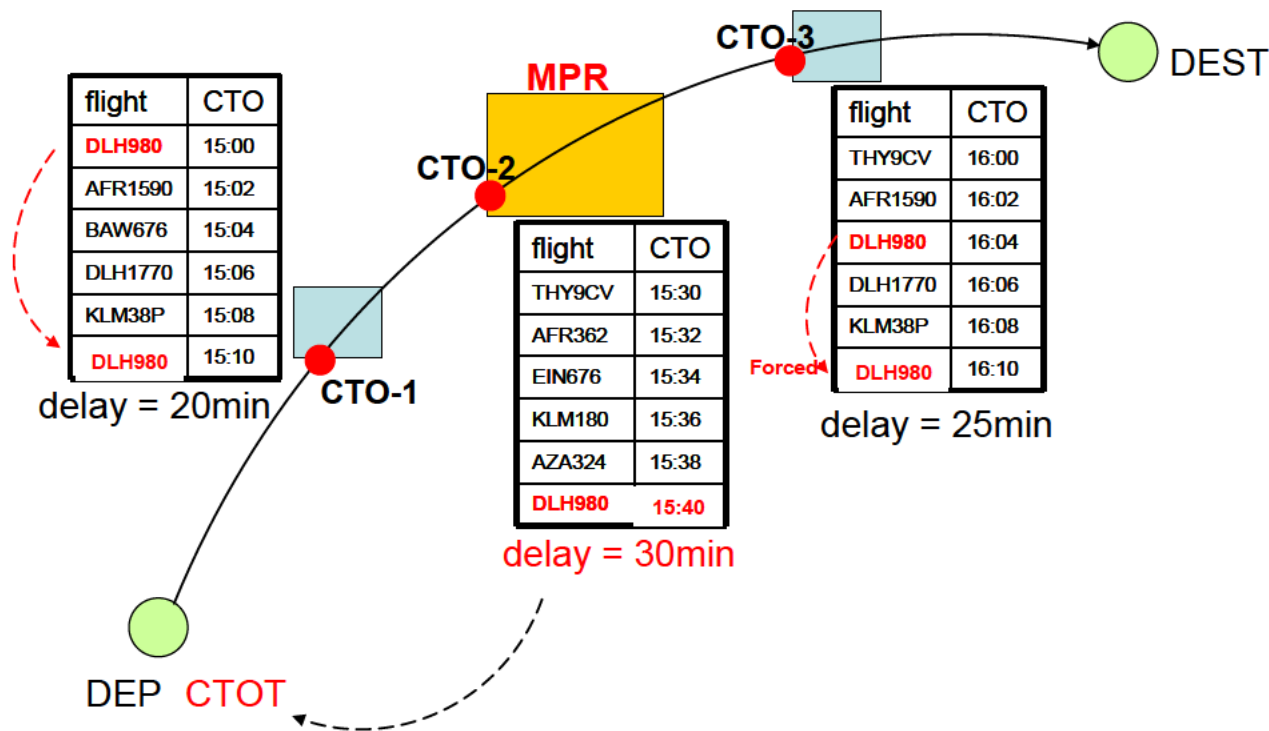

Figure 2: CTOT allocation process.

3.1.1.1.5 Slot Allocation Status

a) Pre-Allocation Stage:

When a regulation is activated, each flight concerned by the regulation is given a provisional slot. This initial reservation is internal to the ETFMS system and is subject to amendment. Due to the constant recalculation of the Slot Allocation List (SAL) as new flight plans arrive, the provisional slot is very likely to be changed.

b) Allocation Stage:

At a fixed time before the Estimated Off-Block Time (EOBT-2h) of each pre-allocated flight, the slot is allocated to the flight and a Slot Allocation Message (SAM) is sent to the AOs and ATC. An allocated slot cannot be further delayed, unless there is a big degradation of the situation, and all slots recalculated by the system. However, if the AO believes the flight cannot comply with the CTOT, the AO should update the EOBT in the Flight Plan and be allocated a new CTOT.

founding members



Avenue de Cortenbergh 100 | B -1000 Bruxelles
www.sesarju.eu

On the inverse, if a flight is in a “Request For Improvement” status, it may be allocated a reduced delayed slot, if a slot becomes available in the system (e.g: an AO sent a Delay message with a new EOBT).

c) Blocked slot:

The system constantly monitors the situation, and performs slot recalculation every 5 min, based on updated data (e.g.: if a flight sends a Delay Message, then its CTOT becomes free. The system will allocate it to another flight).

The system allows modification to the slots for flights having a CTOT from present time + the taxi time and an aerodrome dependant Time to Insert into Sequence (TIS) value.

To protect flights about to depart from instability, a value consisting of adding the taxi time and the aerodrome dependant Time to Remove from Sequence (TRS), before CTOT, the slot becomes “blocked” in the system. This means that if the situation deteriorates and the regulation rate is reduced, the flight about to depart will not be impacted by an additional delay.

As well, when the slots of 2 flights are swapped, (not a CTOT swap, but CTO: Calculated Time Over swap) the one becoming first remains forced in the system, whatever how much time in advance of EOBT is performed the slot-swap. The flight becoming second will be unforced and can still be improved or delayed.

3.1.1.1.6 “Overload” Slots

However, if no slot is found by CASA within a time window of [-20min ← EOBT → +60 min], the system creates an “**overload**” slot. This means that the slot is allocated in addition to the declared regulation rate of the Traffic Volume. This is tolerated as there is always a safety capacity buffer.

There are constraints on Overload slots as they cannot be swapped.

3.1.1.1.7 Automatic Slot exemptions

Some flights may be exempted from a slot allocation, depending on the nature of the flight. Those flights cannot be swapped, as they are not regulated, and therefore do not receive a slot

a) STS exempted flights:

Some Special Status Flights indicators (STS field) filled in the Flight Plan shall give an automatic exemption from flow regulations.

When a flight is in EXEMPTED Status, **no slot is allocated.**

10.1. Flights that Qualify for Exemption from ATFCM Slot Allocation³

The following flights are exempted from ATFCM slot allocation:

- a) flights carrying Head of State or equivalent status [`'STS/HEAD'`].
- b) flights conducting search and rescue operations [`'STS/SAR'`].
- c) flights authorised by the relevant States Authorities to include in the flight plan [`'STS/ ATFMX'`].
- d) flights in state of emergency [`'STS/EMER'`].
- e) flights doing a fire fighting mission [`'STS/FFR'`].
- f) flights conducting a life critical emergency evacuation [`'STS/MEDEVAC'`].

Exemptions should not exceed 0,6 % of any Member State’s annual departures.

b) Long-haul flights coming in from outside the IFPS zone of responsibility:

3 ATFCM Users Manual – Edition 16

There is no control on the departure time of these flights. The flight plan becomes active when the aircraft actually enters the IFPS zone of responsibility, and the system receives an activation message: IFPZ via an FSA (First System Activation) message. As it is already flying, the flight is directly added to the active traffic list; these flights cannot be delayed as they're coming anyway.

The long-haul flights are counted in the regulated Traffic Volume load, but they get no delay. Their Calculated Time Over (CTO) equates their Estimated Time Over (ETO) in the slots allocation system.

c) Global Network impact:

When a flight is in exempted status, it is still counted in the TV load. It doesn't improve the FMP and NM global delay statistics, as it occupies one slot.

3.1.1.1.8 Flights automatically excluded from the Slot allocation process

Some flights are not counted in the TV load, because the flight profile will not impact the ATC controller workload of the regulated Traffic Volume. These flights are not taken into account by the Slot Allocation process; **they do not receive any CTOT.**

Exclusions from the slot allocation process may be done automatically, if previously agreed and automated. If so, CASA "recognises" specific conditions in the Flight Plans and accordingly excludes traffic flows.

Excluded flights cannot be swapped, as they do not have any CTOT.

3.1.1.1.9 Tools

3.1.1.1.9.1 ETFMS: Enhanced Tactical Flow Management System.

This tool is the main NM flow management system, which amongst other things issues the ATFM regulations slots.

On prioritisation perspective, it is used to monitor and manage Flight lists and Traffic Volumes regulations. The tool provides all profiles, FPL's, operational logs and other data of all traffic over the ECAC area; filters permit the operator to sort information according to selected criteria.

The NM operator may edit a new regulation for a Traffic Volume.

The tool also provides a facility to test impact on the network in case of a prioritisation request from an Aircraft Operator or from an FMP. This is the "Network Impact Display window".

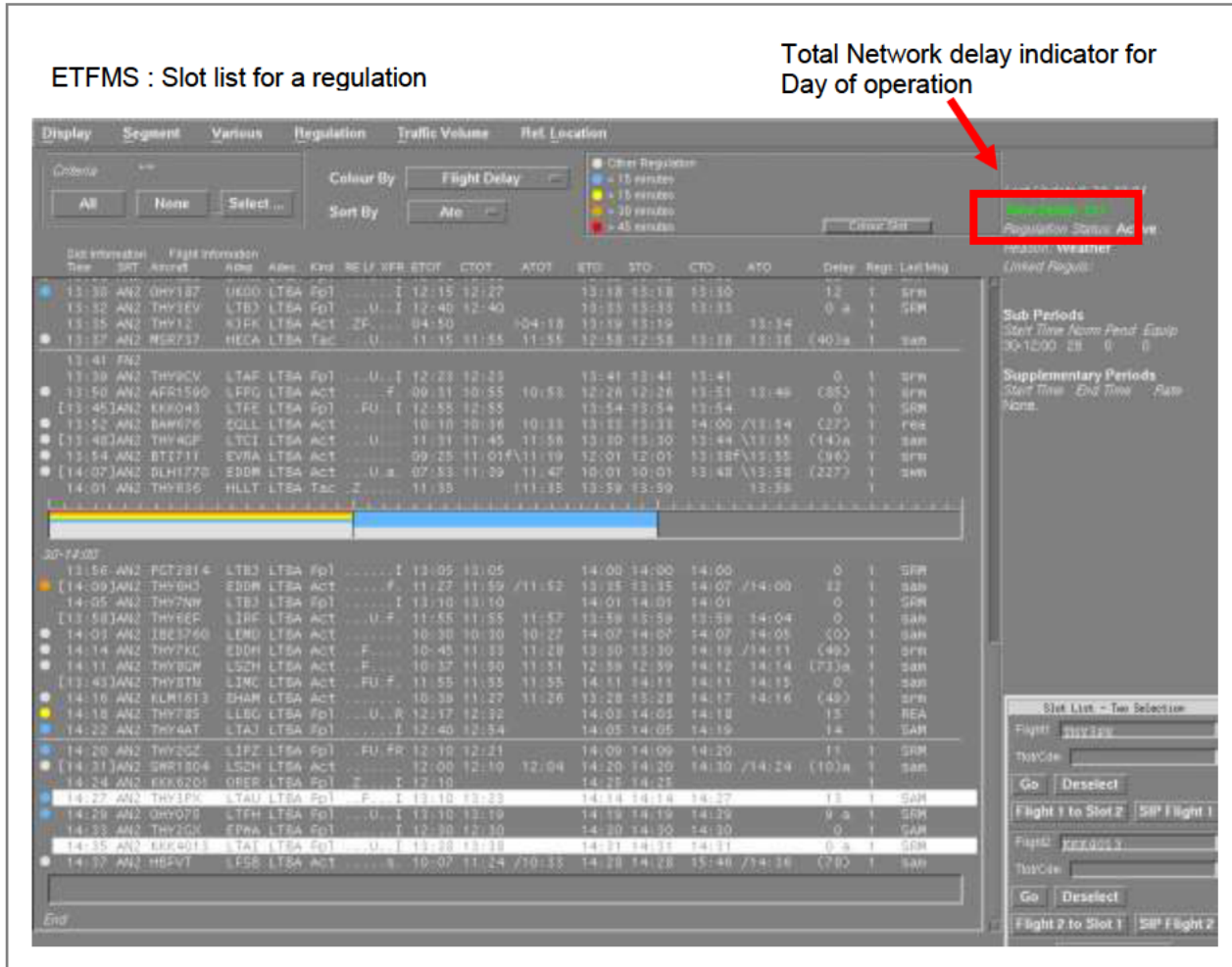

Figure 3: ETFMS Slot list for a regulation.

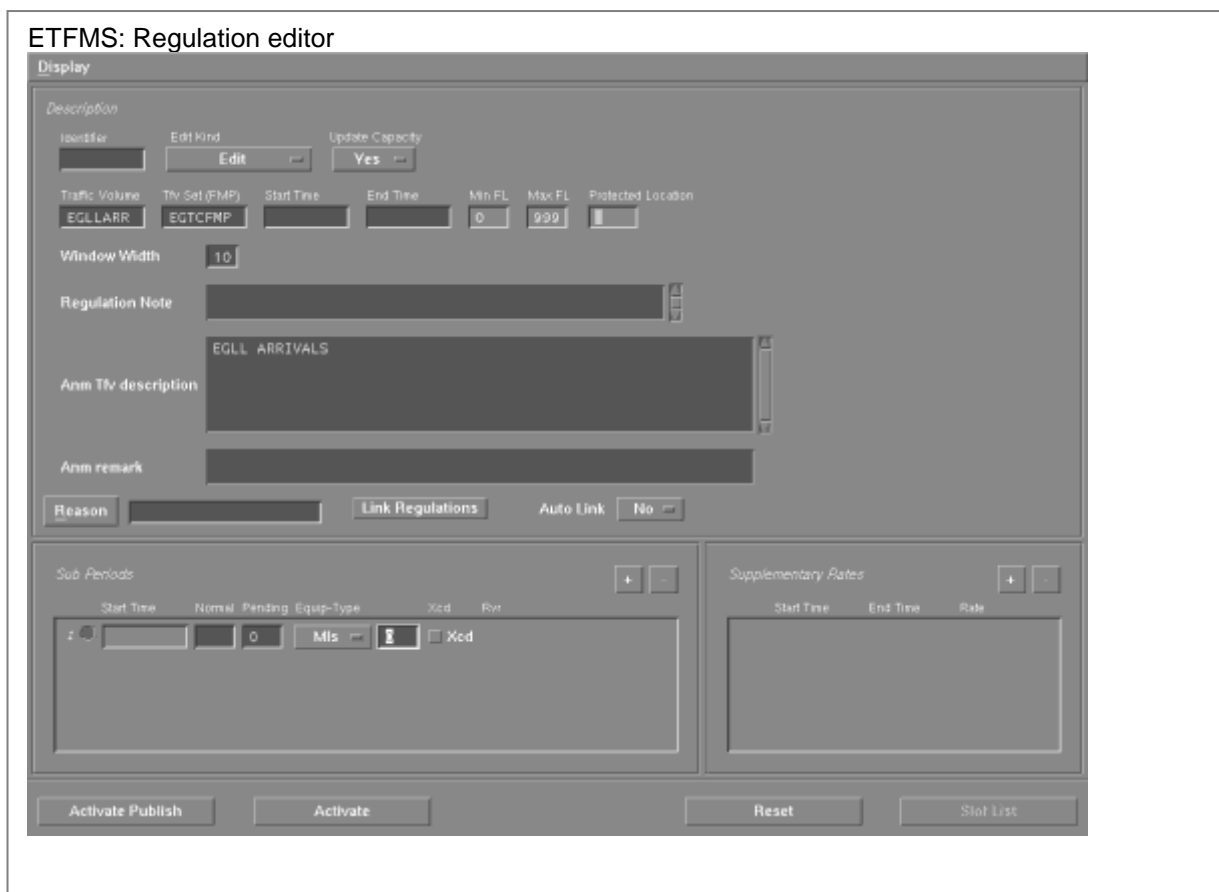

Figure 4: ETFMS: Regulation editor.

3.1.1.1.9.2 NOP: Network Operations Portal.

This portal shares a common view of the air traffic. It provides information used to plan operations in a collaborative way from the Long Term Planning to the Execution phases, and to monitor the real-time status of the traffic, airspace, traffic flow and capacity management measures.

3.1.1.2 Flight Priority Management and Slot-Swapping at NM

3.1.1.2.1 Flight Priority Management

Once a flight is allocated a CTOT, there are ways for improving the situation and prioritising it.

This can be done on Aircraft Operator's request through normal processed Slot Improvement request status, through a specific demand via the NOP e-Helpdesk, or on the phone.

E- Helpdesk:

All prioritisation requests must be done via the NOP E- Helpdesk. This feature is established to provide assistance to those AOs who have critical operational problems which cannot necessarily be solved by use of ATFM message exchange.

The E-Helpdesk is now the principle tool for dealing with requests for help from aircraft operators and flight handling agents. The E-Helpdesk requests have priority over Helpdesk calls.

The average time to process a request is 2min. Depending on the NM operators' workload and on the complexity of the request; it may take a few seconds, up to 15min on heavy disrupted days.

founding members



Avenue de Cortenbergh 100 | B -1000 Bruxelles
 www.sesarju.eu

3.1.1.2.2 Slot extension

A slot extension may be required at the initiative of the TWR, or by the Aircraft Operator. If requested by the TWR for operational reasons, the Network Manager will try to comply with the demand as long as over-capacity is not critical. If requested by an AO, the rules are made to prevent any cheating.

a) Slot Tolerance Window (STW):

The standard slot window is a time tolerance around the CTOT, providing a flexibility of [-5min / +10min] around the allocated CTOT for the aircraft to take-off. This tolerance window is a requirement towards ATC to comply with.

b) Slot Tolerance Window extension:

A Slot Extension means that the Slot Tolerance Window is increased around the CTOT. In the case of a normal Slot extension, this tolerance may be increased of 10min.

Extending the slot tolerance window has no impact on the global delay calculation.

ATFCM User Manual procedure:

5.2.2.1. Slot extensions⁴:

Slot extensions are limited to a maximum of 10' and are considered under the following circumstances:

If **requested by a TWR:**

- For operational reasons the slot extension should normally be given. The appropriate tactical staff should be informed if there is an adverse impact on the load. It will then be the responsibility of the ATFCM to either negotiate extra capacity from the affected FMP or to rectify the load.
- If an unacceptable overload is unavoidable, a slot extension should be refused. Co-ordination with the appropriate tactical staff will be necessary to ensure that nothing can be done prior to refusing a request from a TWR.

If **requested by an AO:**

- If present clock time is still 20 minutes or more before the EOBT required to achieve the CTOT (CTOT –Taxi time) no slot extension should be given. The customer should be instructed to send a DLA message.
- If a flight has already been given a slot extension no further extension should be given. The customer should be instructed to send a DLA message
- If it is within 20' of the EOBT required to achieve the slot (CTOT -Taxi time - less than 20') and no prior slot extension has been given:

1) Check the load. If the extension would create an overload no slot extension should be given unless a swap is possible with a later flight.

2) If the extension would not generate an overload, a 10 minute slot extension may be given.

The capacity should be respected in ALL regulations, not just the most penalizing.

c) Heavy disruption at DEP airport Slot extension:

A specific Slot Extension rule applies for heavy disruptions at Departure airport, such as de-icing, snow, etc. In such conditions, the slot-extension tolerance may be buffered up to a maximum of (-30min / +30min) in the system.

Allowing big extensions of the slot tolerance creates uncertainty on Traffic Volumes load, and may lead to safety issues. The application of this rule should remain exceptional.

⁴ ATFCM Users Manual – Edition 16.

Munich De-icing case: Munich airport (EDDM) has a special feature allowing de-icing slot extension. In this specific case, the Network Manager's ETFMS tool has an option allowing the controller to affect a de-icing slot extension to all or part of the departing traffic.

At non CDM airports, a way to cope with de-icing delay may be to manually extend the taxi-time in the system. But this leads to impact the delay statistics.

Frankfurt case⁵: special procedure for adverse conditions.

In situations with "Adverse Conditions" it is possible for the DFS (Tower) to take the following measures in relation to the Network Manager:

Timely inform the NM Supervisors about extreme situation,

Increase the taxi times using the CSA-Tool function "Variable Taxi Times",

(Only for departure flights with a requested de-icing/anti-icing in de-icing/anti-icing situations) extend the Slot Tolerance Window (max. CTOT +30 minutes). The extension agreement is only valid for one hour and thereafter must be coordinated again.

For any one particular departure flight (e.g. long delay) a certain time of take-off can be agreed upon after coordination with the NM.

3.1.1.2.3 ATFCM Slot Swapping

As an approach to improve the situation, the ATFM Slot Swapping is a facility provided by NM to Airspace Users to exchange two regulated flights slots. It is subject to constraints to prevent from safety issues.

An AO can request an ATFM slot swap for two of its flights that were affected by the same Most Penalizing Regulation. By swapping, the AO penalizes one aircraft and promotes another one. No other airliner would have disadvantage from the swap between the two flights.

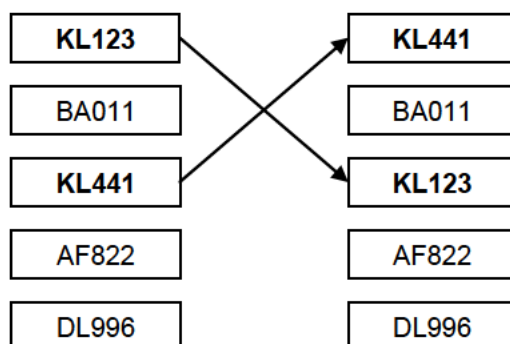

Figure 5: slot-swapping principle.

ATFM Slot swapping (see Figure 1) is an application that allows airlines to prioritise flights by exchanging the slot of one flight with the slot of another. It would give an AU the opportunity to exchange the departure order of two of its aircraft penetrating the same regulated area. This allows the AU to reduce the delay of a commercially sensitive flight at the cost of another of its flights.

⁵ information by Patrick SPIJKERS (FRAPORT), March 2012

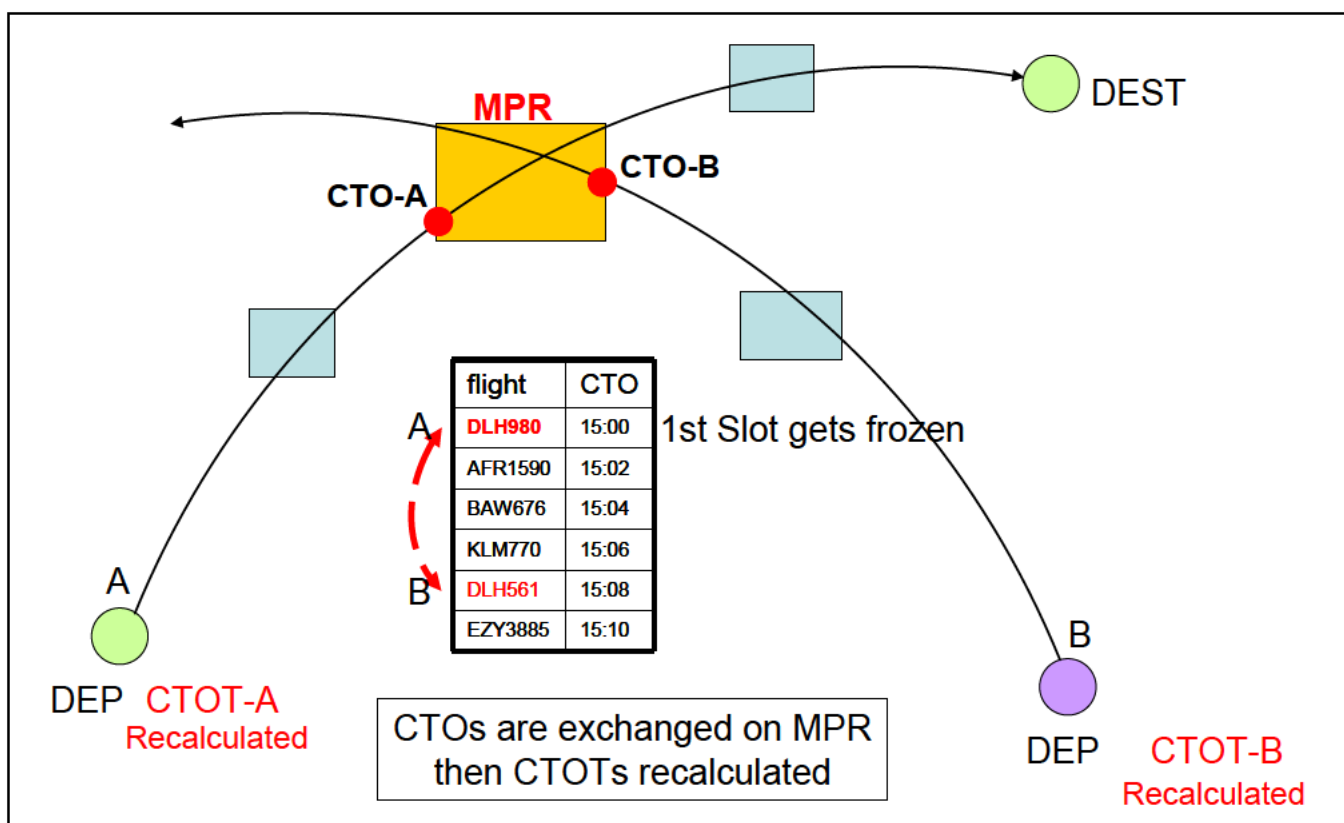

Figure 6: ATFM slot-swap example

a) NM Slot Swapping procedure:

AOs may submit their request for a slot swap to the Network Manager either directly to the Central Flow Helpdesk or via a FMP. The prerequisites are that both flights have their slots issued and that they are both subject to the same Most Penalising Regulation. A maximum of one swap per flight is authorised, provided that the swap is feasible and has no negative network effect.

Here is the Slot Swapping procedure, last amended on March 30 – 2012, and approved for implementation as from April 19, 2012.

ATFCM Operations Manual edition 16.0⁶

8.2.1.5 Swap Two Flights

The ETFMS slot swapping functionality is used to swap flights when requested by aircraft operators and also to improve another flight if an aircraft operator requests a slot extension (i.e. instead of forcing the flight).

Procedure

The procedure should be applied when a request for slot swapping is received from an aircraft operator or FMP

Aircraft operators shall only request swaps concerning flights for which they are the responsible operator (OPR field) or where there is a formal agreement between both aircraft operators for swaps to take place between the concerned operators.

Conditions

- A request for a slot swap from an AO must be submitted via the E-Helpdesk

⁶ OI-12- Slot Swapping Procedure Update- April 19, 2012.

- NMOC shall not check whether flights are from the same operator or where there is a formal agreement between both aircraft operators for swaps to take place between their flights
- FMPs can request swaps for two flights of the same aircraft operator or, during critical events at airports, also for different aircraft operators;
- The two concerned flights must be in status slot issued;
- The two flights must be subject to the same most penalizing regulation;
- Only one swap per flight shall be accepted, except critical events (CHAMAN).

Internal Procedure

1. Whenever a request for a slot swap is received at the E-Helpdesk it should be handled by the receiving position
2. The swap should not be performed if the warning window (NID) shows an over delivery in the traffic volume counts.
Where the swap may be performed, the improved flight should be left forced. The deteriorated flight should be unforced in order to:
 - Better manage the traffic load, in case of a deep rectification (e.g deterioration of the acceptance rate);
 - Allow further improvement of the CTOT, as a result of the true revision process.

b) Slot status for a slot-swap request:

Slots-swaps are only applicable for flights having their CTOT issued: being in the **allocated status**. Before 2h in advance of the Estimated Off-Block Time (EOBT) filled in the Flight Plan, the CTOT is not yet issued by the SAM (Slot Allocation Message). However, Airspace Users may have a view of the pre-allocated slot in the CHMI tool, but they can't raise any slot-swapping request.

Slot-swaps can only be performed if the flights are in **Ready Status (REA)** or **Request For Improvement (RFI)** status. If one of the two flights is not in REA or RFI status, then the system rejects the slot-swap.

Moreover, slot swaps cannot be performed if one of the two flights has an **“overload” slot**.

Another limitation done by the system is that swaps cannot be performed between a regulated flight, and a **non-regulated flight**, even having the same route (e.g. if the second one crosses the traffic volume after the time the regulation is over).

c) Time to Remove from the Sequence:

If the slot-swap request is issued too close from departure of the first flight, the system will not allow the slot-swap. This time buffer is the Time to Remove from the Sequence (TRS) provided by the airport. It protects the TWR controller from last minute Runway Sequence change that couldn't be performed.

d) Time to Insert in the Sequence:

The same way, if the new CTOT of the second flight is too close from present time, the system will not allow the slot-swap. This time buffer is the Time to Insert in the Sequence (TIS) provided by the airport. It protects the TWR controller from last minute Runway Sequence change that couldn't be performed.

e) Impact of a slot-swap on the Network:

When a slot-swap request is received at the NOP e-Helpdesk, the controller checks for safety. He uses the Network Impact display window “Display Help” (see example hereunder) to perform his analysis.

The slot-swap facility doesn't swap CTOTs: it does exchange the CTO (Calculated Time Over) of the two flights entering the same Most Penalizing Regulation traffic volume.

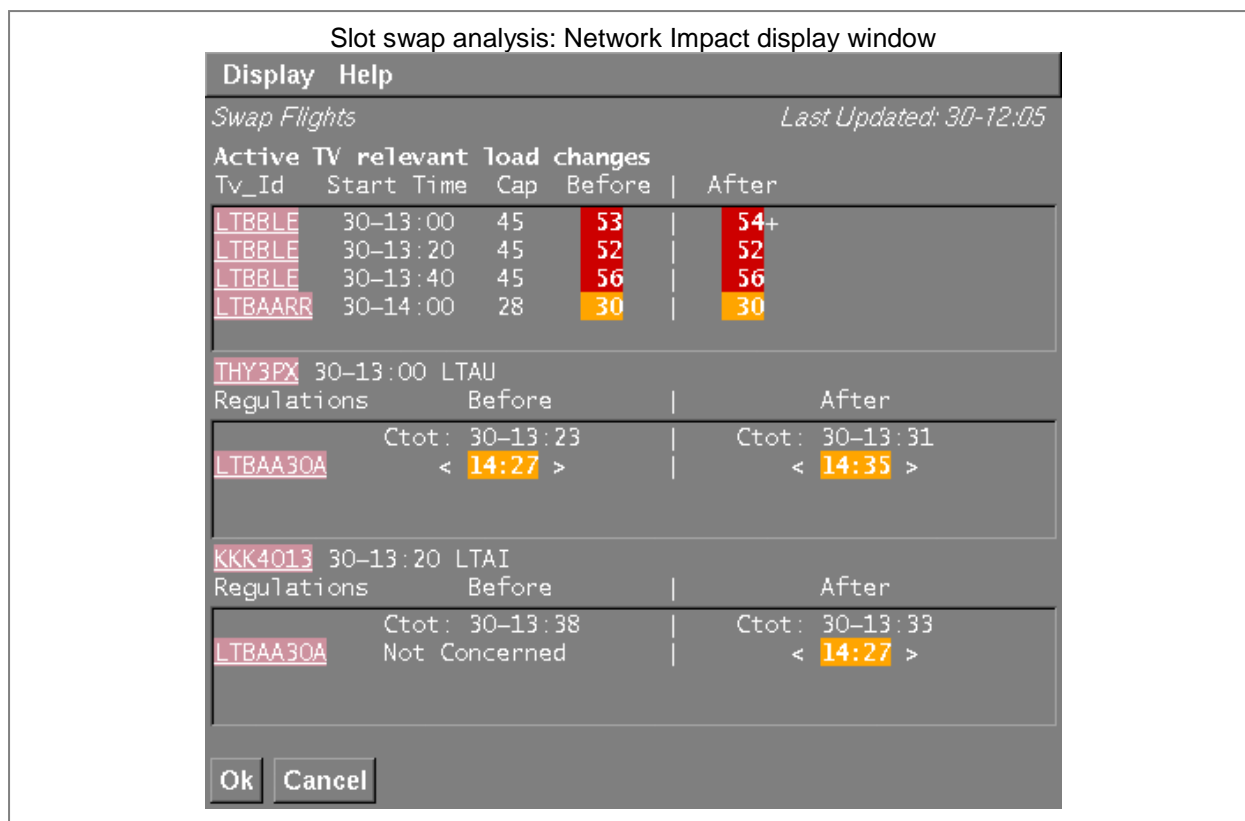

Figure 7: Network Impact display window.

The NID can be considered as a “what-if” functionality.

The ETFMS calculates what would be the new trajectory of the 2 flights: new times to enter all the traffic volumes along the route of the flight.

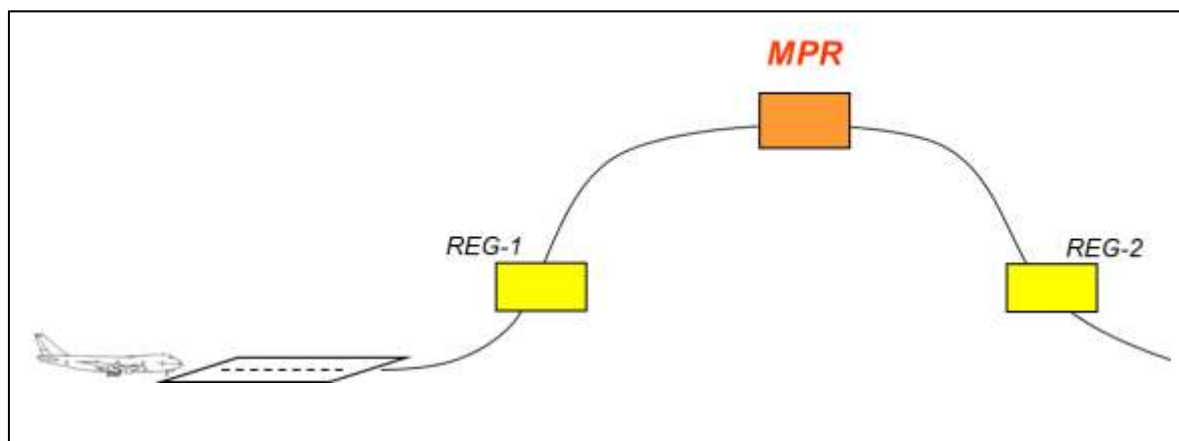

Figure 8: Trajectory of a flight impacted by several regulations.

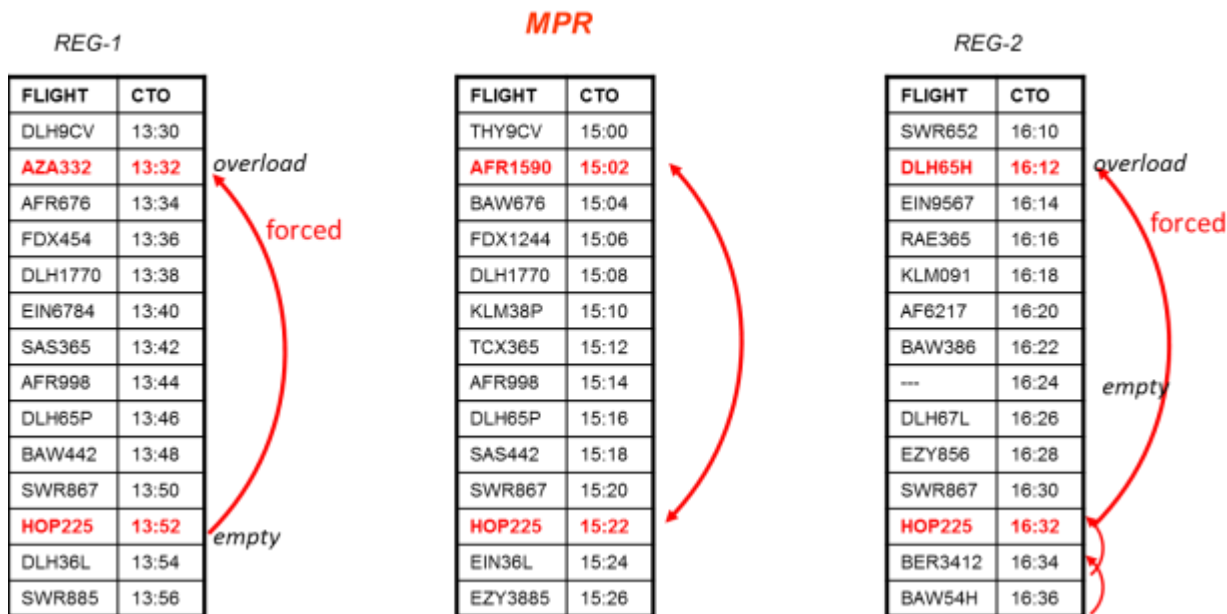

Figure 9: Impact of a slot-swap into the several slot Sequences along the route of the flight

In the Most Penalising Regulation, the two slots are exchanged so it doesn't create any overload.

When the CTO of a flight is forced to a specific time, it could happen that the slot is not empty, already allocated to another flight. If this is the case, CASA forces the new flight into the same slot, which means that there are two flights for one single slot.

However, in Air Traffic Control flights never come at exactly the planned time, there is a punctuality margin.

Taking the forced CTO time as the reference, CASA queries the list of slots in both 'earlier' and 'later' time directions until it finds the first empty slot.

CASA blocks this slot to remain empty, to counter balance the other slot that is filled twice (the original flight + the forced flight).

Safety check for overload slot:

Then the system checks the entry counts of all the traffic volumes along the route of the two flights.

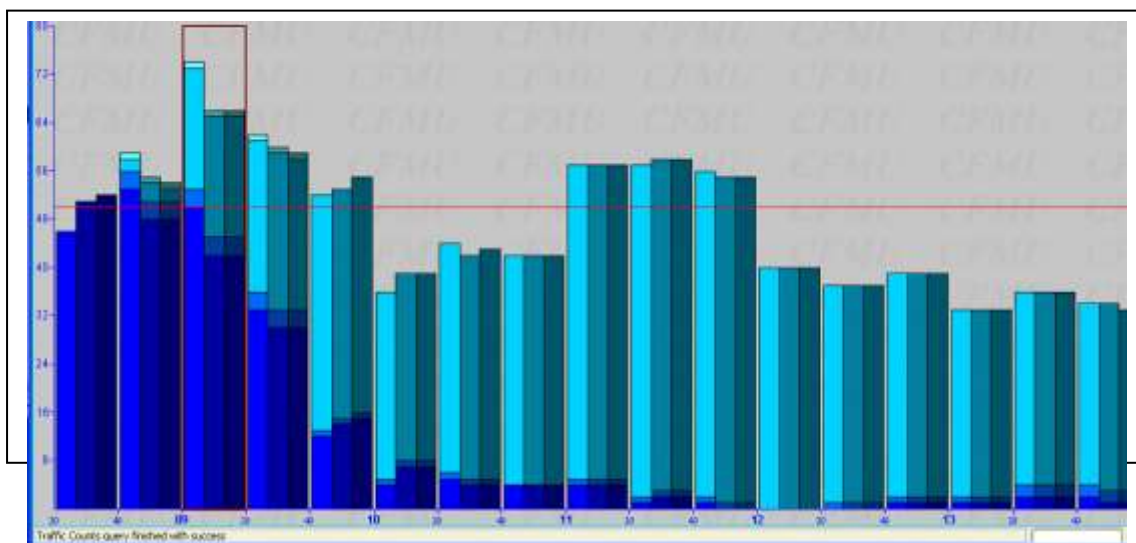

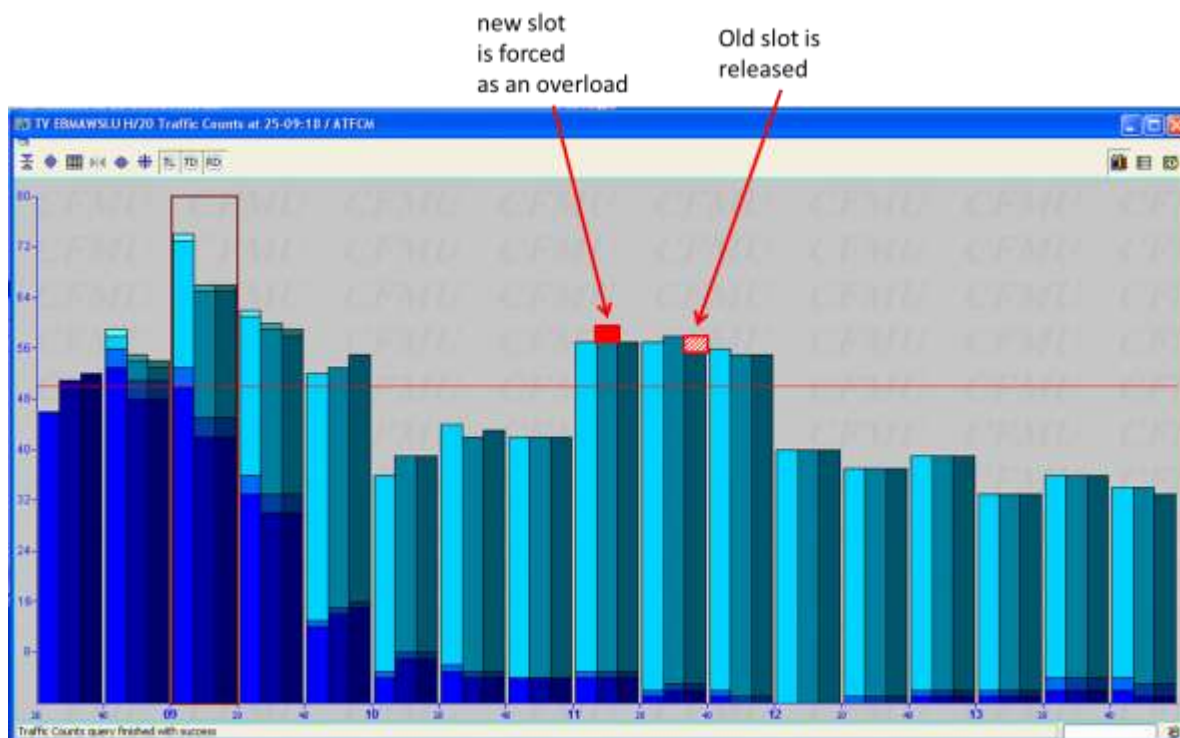

Figure 11: Example: Entry counts in REG-1 after the slot-swap: HOP225 is forced as an overload into an earlier slot

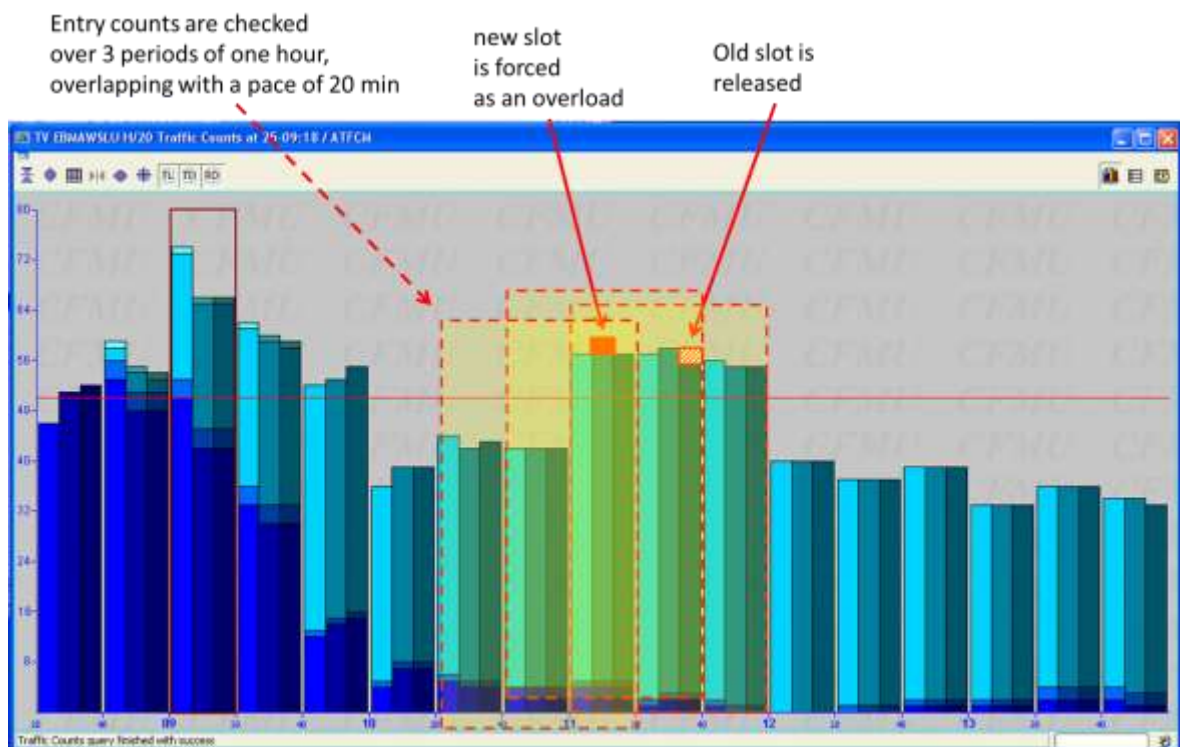

Figure 12: Example: Safety calculation of overload slot on Entry counts in REG-1 after the slot-swap.

Each period of one hour is sliced into 3 sub-periods of 20 min each. The traffic in the Regulation Sequence will be considered SAFE if:

- number of flights \leq number of slots per period of one hour.
- Rolling over 3 periods of one hour overlapping by a pace of 20 min

Executing the Slot-swap:

If the NMOC operator considers that the slot-swap is safe, he will accept the request and execute the slot-swap in the ETFMS.

As a consequence of the re-calculation in the CASA system, the two flights are issued a new CTOT, and slot status becomes frozen for the two flights.

For the first flight in the Regulation Sequence, the operator shall leave the status of the slot as 'frozen', thus the CTOT is blocked: the system will not impact it when doing its re-calculation every 5 min.

The NMOC operator will then manually unforce the slot of the flight who became second to allow for flexibility in the system in case the regulation capacity would evolve.

The second flight's slot could be either improved as a result of the cyclic CASA recalculation process, or on the other hand it could also be delayed in case of drastic capacity rate reduction (e.g. accident on the runway).

f) Slot-swaps triggered by NM:

NM concretely uses the swap feature in the case when a flight requests a slot extension. If occurring, NM tries to identify another same MPR flight within the 10 min, being in REA status. If yes, NM performs the swap, it is a win/win situation. If no, this is processed as a standard slot extension.

3.1.1.2.4 CHAMAN: Management of Critical Situations at Airports

CHAMAN (CHAos MANAGEMENT) is a departure regulation procedure, developed years ago.

It is a procedure that can be activated in times of very heavy weather problems at the airport. Once activated, flights process through de-icing and depart at ATC discretion, and CTOTs can be disregarded.

The CHAMAN procedure allows the TWR to trigger departure flights swaps according to their readiness, disregarding ATFCM departure slots. TWR has authority to build its own flight departure sequence, and then coordinate with NM. NM monitors the impact on the network perspective. "Sensitive" flights (STS/PROTECTED) cannot be swapped and should respect their slot as allocated by NM.

However, TWR having decisional power to arrange its own sequence of regulated flights may impact the Network safety. When CHAMAN is activated, the authorised rate for departure is significantly reduced. This rate is agreed when subscribing to the procedure.

The CHAMAN procedure is rarely used, and tends to be abandoned by airports with implementation of CDM.

3.1.1.2.5 Forced Slot

NM may force the system to improve a slot. The operator fills in manually the new (ideally requested) CTOT, and checks the impact on the network with the "Network Impact Display Window" before validating.

Forced slots cannot be swapped.

3.1.1.2.6 Best equipped prioritisation

London Heathrow airport is equipped with a Microwave Landing System (MLS) which allows curved approach procedures. When the landing capacity is reduced on critical situations, the MLS procedure applies: MLS equipped aircraft are authorised to land on the Departure Runway. This is limited to 6 slots / hour.

These additional capacity slots are allocated to MLS equipped aircraft only. The Flight Plan indicates if the aircraft is equipped.

When the MLS procedure applies, MLS equipped aircraft landing at Heathrow get a much better slot than others. Slots allocated with regards to aircraft equipment cannot be swapped. A non MLS flight shall not be forced into an unoccupied MLS slot or swapped with an MLS equipped flight that is occupying an MLS slot.

3.1.2 A-CDM operating method⁷

3.1.2.1 The A-CDM concept

Airport Collaborative Decision Making (CDM) is an important enabler of Air Traffic Management (ATM) capacity and efficiency. The objective of the Airport CDM (Collaborative Decision Making) project is to improve the overall efficiency of operations at an airport, with a particular focus on the aircraft turn-round procedures.

Airport Collaborative Decision Making is about improving the way Operational Partners at airports and the European ATM network work together at an operational level. Airport CDM also addresses the need for operational decisions to be made collaboratively thus providing a substantial contribution to maximizing capacity and efficiency.

This is achieved by enhancing the decision-making process by the sharing of up-to-date relevant information and by taking into account the preferences, available resources, and the requirements of those who are involved at the airport (such as airline operators, air traffic control, handling agents, and the airport management). The concept of Airport CDM does not imply any particular system or architecture. Rather, it is an approach to using aeronautical data, based on sharing data between all Partners, ensuring a common view of the ATM and airport environment on all levels.

Airport CDM allows an Airport CDM Partner to make the right decisions in collaboration with other Airport CDM Partners, knowing their preferences and constraints and the actual and predicted situation. The decision making by the Airport CDM Partners is totally dependent upon the sharing of accurate and timely information and upon adapted Airport CDM procedures, mechanisms and tools.

Airport Collaborative Decision Making (Airport CDM) is now embedded in the ATM operational concept as an important enabler improving operational efficiency, predictability and punctuality to the ATM network and airport stakeholders. Airport CDM have an impact on the operating efficiency of airport partners, and may eventually contribute to reduced buffer times for resource planning and flight times due to enhanced predictability.

⁷ This section is derived from the Airport CDM Operational Concept Document, Ed.: 3.0, September 2006,

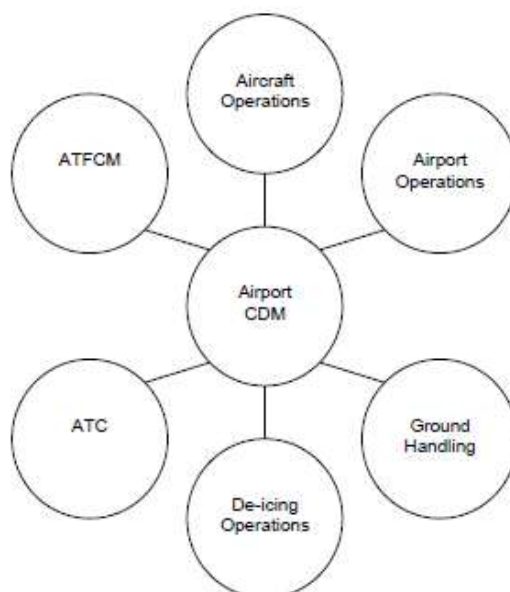

Figure 13: A-CDM Logical elements.

The Airport CDM concept may be summarised as follows:

1. (Airport CDM) Information Sharing is essential in that it forms the foundation for all the other elements and must be implemented first.
2. The Milestones Approach (Turn- Round Process) aims to achieve common situational awareness by tracking the progress of a flight from the initial planning to the take off.
3. Variable Taxi Time is the key to predictability of accurate take-off in block times especially at complex airports.
4. (Collaborative) Pre-departure Sequence establishes an off-block sequence taking into account operators preferences and operational constraints.
5. (CDM in) Adverse Conditions achieves collaborative management of a CDM airport during periods of predicted or unpredicted reductions of capacity.
6. Collaborative Management of Flight Updates enhances the quality of arrival and departure information exchanges between the Network Operations and the CDM airports.

3.1.2.2 Information Sharing

The key element of the CDM concept is information sharing, so that all the partners have the whole picture and consequently gain efficiency. It is essential for airports to share dynamic and highly accurate data with the European ATM network.

Info sharing is first of all locally and only later it is info sharing with NMOC. The exchange of dynamic CDM information between the NM Operations Centre (NMOC) and the airport is realised by:

- a) Sending DPI messages from the airport concerned to the NM. The Departure Planning Information (DPI) messages supply the Central Flow Management Unit of EUROCONTROL with airport situational information directly from the airports Collaborative Decision Making (CDM) systems in order to update the real time flight situation prior to take-off. These messages contain latest information on e.g. estimates or target times for take off of a particular flight, the aircraft type, taxi times, and the SID.

- b) Sending Flight Update Messages (FUM) from the NM to the airports concerned. The FUM provide CDM airports with the flight status and an accurate estimated landing time of arriving flights, improving the planning of outbound flights.

The Data exchange at Airport CDM is used within the aircraft turnaround process so as to:

- Facilitate an improvement in the awareness of all airport partners.
- Trigger updates of downstream information.
- Help identify potential delays of the aircraft, triggering re-planning.
- Enable collaborative decisions to be made.

The main milestones for data exchange are:

| NUMBER | MILESTONE |
|--------|---------------------------------|
| MST1 | ATC Flight Plan Activation |
| MST2 | EOBT-2 hr |
| MST3 | Take off from outstation |
| MST4 | Local Radar Update |
| MST5 | Final approach |
| MST6 | Landing |
| MST7 | In-block |
| MST8 | Ground handling starts |
| MST9 | TOBT update prior to TSAT issue |
| MST10 | TSAT Issue |
| MST11 | Boarding starts |
| MST12 | Aircraft ready |
| MST13 | Start up request |
| MST14 | Start up approved |
| MST15 | Off-block |
| MST16 | Take Off |

Table 1: Data exchange milestones at CDM Airport.

3.1.2.3 The Pre-Departure Sequence

In the CDM airport, the pre-departure sequence is optimised for the best efficient use of the runway. The setting up of the pre-departure sequence is based on most reliable and up-to-date information shared between all the partners.

To prepare the aircraft ready for departure, the Airspace User coordinates with the airport services (ground handlers) and calculates an accurate estimated time when the aircraft will be ready to leave the block: the TOBT (Target Off-Block Time). The Airspace User shares this TOBT with the CDM partners.

Based on the TOBT, the system builds the pre-departure sequence, taking into account parameters such as:

- The VTT (Variable Taxi Time): an accurate estimation of taxi-time from block to the allocated runway, depending on where the aircraft is parked with regard to the runway threshold.
- The runway capacity

- The runway queuing time: the tower controller maintains a “pressure” at runway holding point to ensure there is no loss of capacity, maximising the use of the runway. However, queuing should not exceed a certain time or number of aircraft (e.g. runway pressure is 4 to 6 aircraft at Zurich airport). A runway pressure of 4-6 A/C results in an average of 6-10 min at runway holding point. (e.g. *DMAN tests at ARN goal for 2-3 acft*)
- The pre-departure sequence is set up in accordance with the CTOTs issued by NM, if any.

3.1.2.3.1 The TSAT: Target Start-Up Approved Time

As an output of the above parameters, the CDM system issues an allocated time for leaving the block: the TSAT (Target Start-up Approved Time). The TSAT is calculated so as to best respect the TOBT, taking into account constraints and parameters described in above paragraph (VTT, RWY capacity, RWY pressure, CTOT).

The TSAT is transmitted to the Airspace User.

The pre-departure sequence is the list of aircraft planned to depart, in the order of their allocated TSAT: it is the order that aircraft are planned to depart from their stands/parking positions.

The Tower controller has the possibility to rearrange this sequence on operations so as to optimize the use of the runway even better, e.g. grouping take-offs by wake-turbulence category. The departure sequence is the pre-take off order where ATC organise aircraft at the holding point of a runway.

The order of flights can change between pre-departure and departure.

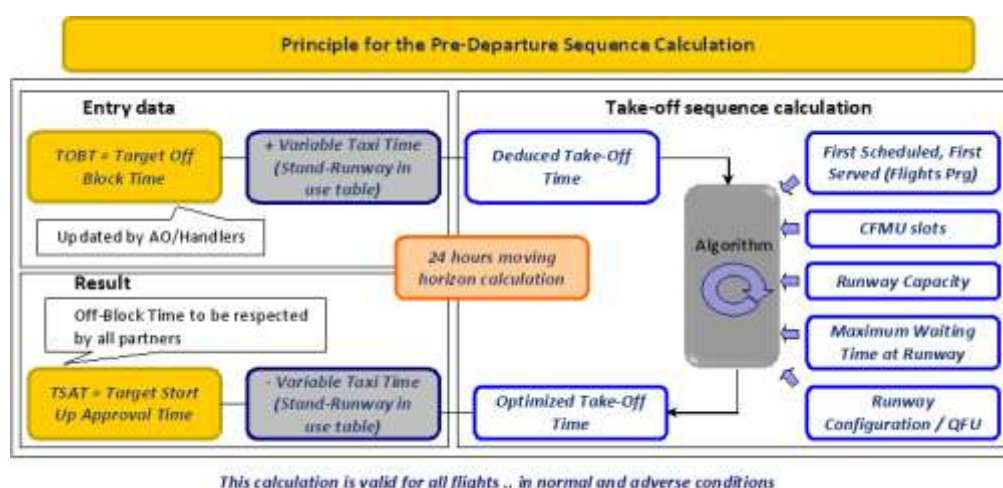

Figure 14: Principle of the Pre-Departure Sequence calculation.

The pre-departure sequence planner calculates and distributes a start-up sequence to all A-CDM partners that reduces fuel-burn, optimises runway throughput and aids recovery from disruption.

The TSAT Algorithm solves a very complex problem – balancing varying demand against capacity on the runways while dealing with known constraints such as TOBT, taxi time, stand contentions and flow restrictions on SIDs, CTOTs and low-visibility adverse condition scenarios.

3.1.2.3.2 The A-CDM Departure Management Tool (DMAN)

The A-CDM DMAN builds an equitable sequence based on dynamic demand and constraints.

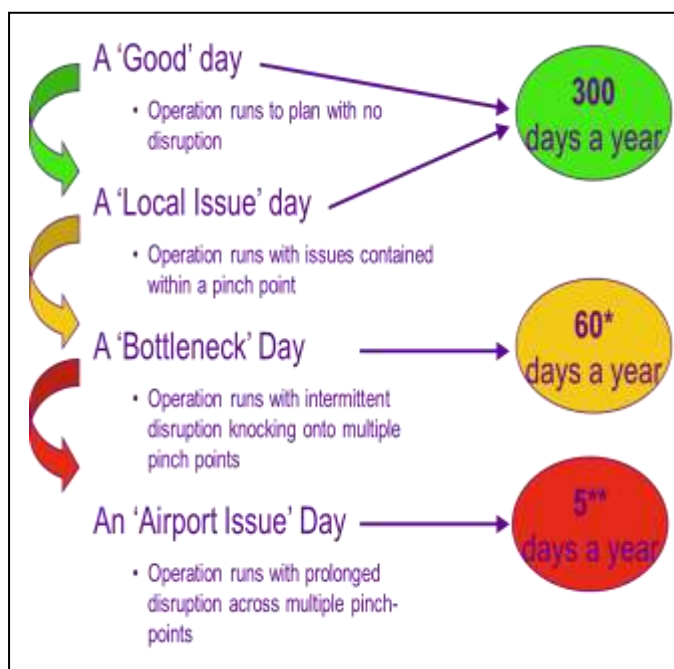

A-CDM Procedures call for accurate and stable TOBT (-20mins before departure) to allow an optimal pan airport departure sequence to be generated. Unplanned events can be accommodated by amendment of TOBT. In these situations TOBT = TSAT and start approval is given inline with airline departure request

TOBT v TSAT increases beyond +10mins for limited periods throughout the operational day. ATC Mitigation measures are used to aid recovery. Any departure delays are continuously optimised up to TSAT -5mins when TSAT locks. TOBT value (set @ -20mins) can be used as the inter-airline pseudo priority.

TOBT v TSAT increases beyond +10mins for a prolonged period of the operational day. Demand has often been pre-emptively reduced in anticipation e.g. HADACAB. TOBT value (set @ -20mins) can be used as the inter-airline pseudo priority.

Figure 15: A break-down of a typical year for London Heathrow.

3.1.2.4 The TTOT to CTOT convergence process

3.1.2.4.1 The A-CDM DPI messages

The purpose of the Departure Planning Information (DPI) message is to supply the Network Manager with flight related updates that are only available from sequencing tools (e.g. DMAN), CDM Airport systems and TWR systems or data that is only available shortly before departure.⁸

The DPI supplies the Network Manager with most recent and accurate flight plan data compared with what is available from IFPS.

The DPI can be triggered by ATC (TWR) systems, by sequencing tools (e.g. DMAN) or by Collaborative Decision Making (CDM) systems at airports.

DPI messages data:

The main data to be retrieved via the DPI messages are an accurate estimation of:

- The Take-Off time
- The taxi-time
- The SID

For CDM systems, the DPI message can also contain updates of:

- The Aircraft type
- The aircraft registration
- 24 bit ICAO aircraft address

⁸ Source : DPI Implementation Guide (Ref : URB/USD/DPI_Impl_Guide v1.600)

Types of DPI messages:

There are five types of DPI messages, where each DPI message gives a more accurate update of the flight:

| DPI-type | DPISTATUS |
|----------|-----------|
| E-DPI | EARLY |
| T-DPI-t | TARGET |
| T-DPI-s | SEQ |
| A-DPI | ATC |
| C-DPI | CNL |

- **E-DPI (Early DPI):** sent at EOBT-3hrs. The transmission of an E-DPI confirms to the Network Manager that an Airport Slot and a Flight Plan have been correlated for a specific flight. It supplies ETFMS with a first estimation of the Taxi-Time (EXOT), and ETOT. At this early stage, the ETOT calculation is based on either **EOBT/SOBT** depending on the CDM Airport.
- **T-DPI-t (Target DPI-target):** sent at EOBT-2h. The Target DPI message provides a TTOT based on the TOBT that is made available by the Airspace User, TOBT designating the time at which the aircraft is planned to be ready (doors closed and pushback truck available) according to the Airspace User perspective (taking into account the Ground Handler service provider estimate). The T-DPI-t is revised on update of the TTOT, calculated from a revision of the TOBT provided by the Airspace User.
- **T-DPI-s (Target DPI-sequenced):** sent at TSAT Issue/Publication. (e.g. Paris-Charles De Gaulle and Zurich issue their TSAT at EOBT-40min). In T-DPI-s, the TTOT is calculated by the pre-departure sequencer with the application of airport constraints (includes the ATC delay at Departure airport). Depending on the CDM airport, the T-DPI-s TTOT may either reflect the Pre-Departure Sequence TTOT (PDS) in which case it is called the 'TTOT shadow' or include that CTOT constraint in which case the TTOT is within the CTOT Slot Tolerance Window.
- **A-DPI (ATC DPI):** sent at Actual Off-Block, it provides the Actual time when the aircraft has pushed back. This allows a more accurate traffic prediction.
- **C-DPI (Cancel DPI):** sent at any interruptions in flights' progress and new TOT is not yet known. It is used to cancel a previously sent DPI information.

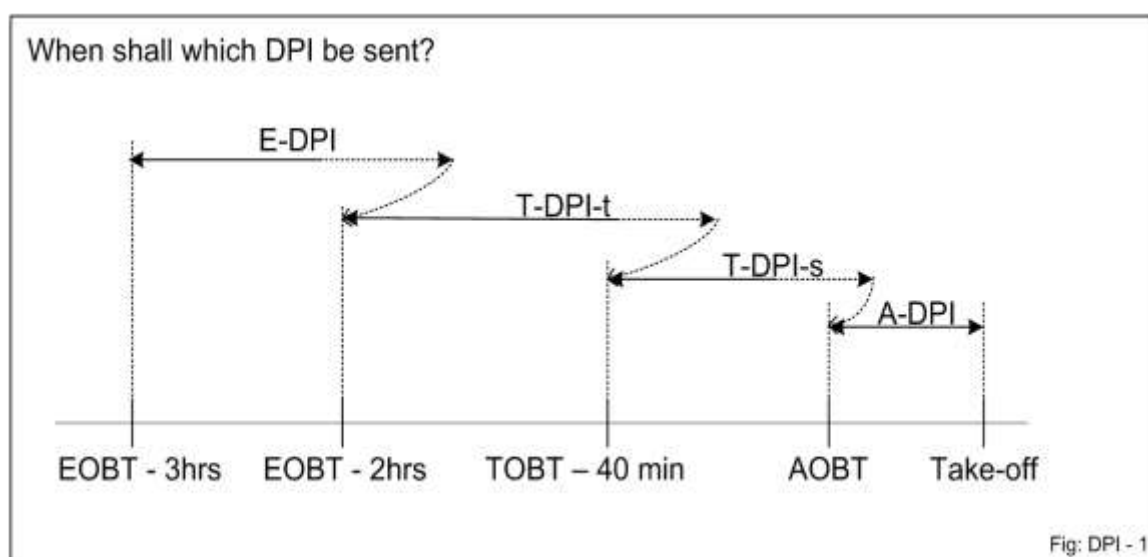

Figure 16: A-CDM DPI timescale

3.1.2.4.1 Evolution of TTOT in DPI messages at specific CDM Airports:

CDM airports have a margin of flexibility to implement the DPI messages. Some of them chose to implement a process to allow for CTOT improvement, described here as the “TTOT to CTOT convergence process”.

When receiving a t-DPI-t message, the ETFMS software considers the TTOT in the message as the earlier time the flight can depart from the CDM airport. In case there is a CTOT improvement, the TTOT is the earliest limit to which the CTOT can be improved. It could be called “not slot before time”.

When sending the t-DPI-s message, the airport has 2 options:

- Option 1: the TTOT is aligned on the CTOT. In this case there can be no slot improvement, but the time is stable.
- Option 2: to allow for CTOT improvement, the TTOT indicated in the t-DPI-s message is still the ATC TTOT, i.e. the best time the airport can provide for departure if there would be no regulation. When receiving a TTOT outside of the CTOT slot tolerance window, the ETFMS software recognises that this is a “shadow TTOT”, allowing for CTOT improvement. Although a t-DPI-s is received, the flight list in the ETFMS shows a ‘t’ flag as for targeted flight, and the flight is put automatically in REA status. The log of the flight shows that the t-DPI-s message has been issued.

Then, as clock goes on, the CDM airport sends a revision of the TTOT, pushing it towards the CTOT. This revised TTOT in the t-DPI-s revision message becomes the new “not slot before time” in case of CTOT improvement by CASA.

After a few occurrences, the TTOT indicated in the t-DPI-s message ends to be inside the flight’s CTOT Slot Tolerance Window [-5; +10]. Therefore, the ETFMS flags the flight as “sequenced” and no CTOT improvement is possible anymore.

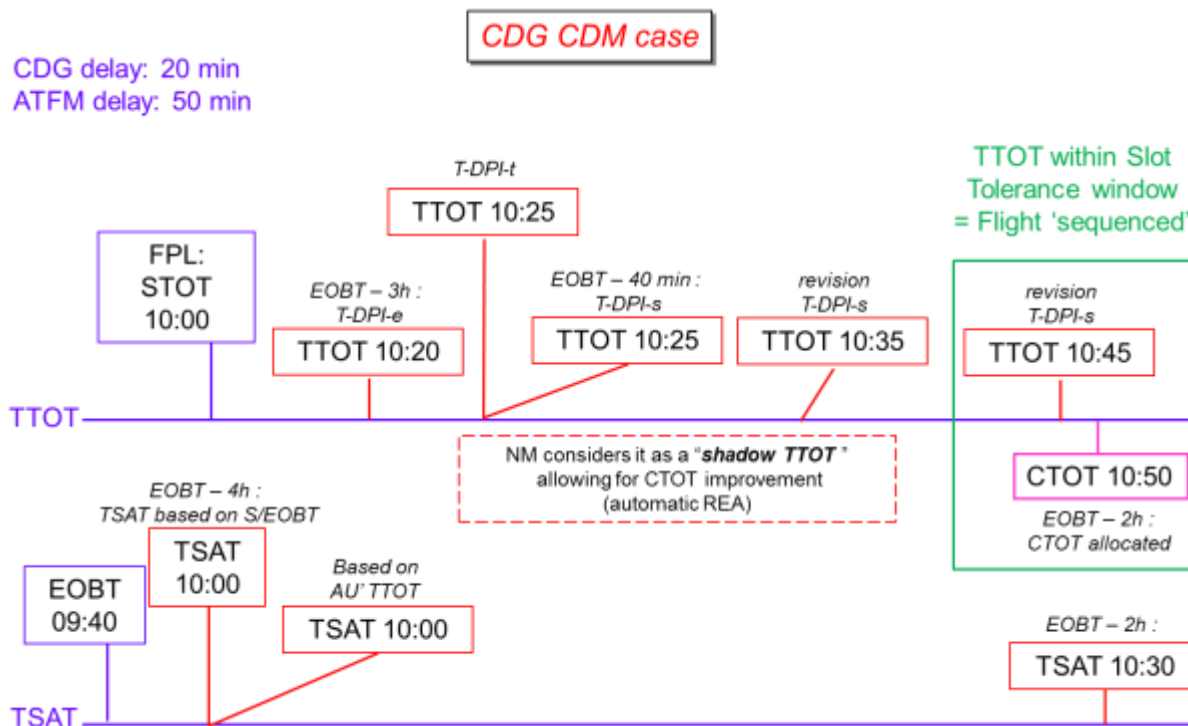

Figure 17: Paris Charles de Gaulle's (CDG's) CDM case.

Few airports have the A-CDM label. Examples are Paris-Charles De Gaulle (LFPG); Munich (EDDM), Frankfurt (EDDF); London-Heathrow (EGGL); and Brussels (EBBR).

Some other airports are in the process of implementing the CDM and depending on their progress are already sending DPI messages to the Network Manager.

3.1.2.5 Flight priority in the Pre-Departure Sequence (PDS)

ATC initially sequence flights in the order that the confirmed TOBTs are received. In the situation where an Aircraft Operator has indicated a preference between specific flights operated by that Aircraft Operator, ATC also endeavour to take into account the preference request providing that flights operated by other Aircraft Operators are not penalized⁹. The pre-departure sequence is then finalized considering any other constraints such as CTOT and other traffic.

Regulated flights do not have priority over non-regulated ones in Pre-departure Sequencing, but adherence to the ATFM slot and the objective of having a regulated flight airborne within its CTOT window is considered as a constraint by ATC when building and managing the pre-departure sequence.

Current prioritisation practices in the Pre-Departure Sequence

There is no formal process to allow airlines to prioritise a flight if needed. It is felt that on airport congestion at airline Hub, the PDS-swap would be of great interest if the facility was available.

In practice, at his Hub, an Aircraft Operator manages to arrange improving a flight by coordinating on the phone in an informal way:

- When the OCC flight dispatcher wants to prioritize a departure, he calls the Station Supervisor or duty manager to arrange with him to put more efforts on this specific aircraft preparation.
- The Station Flight Coordinator monitors preparation of the aircraft and updates the ED (Estimated Departure). The TOBT is then revised in the system, and it is processed by the algorithm which results in a new TSAT.

In theory, if the Station Service is owned by the airline (e.g. Air France in Lyon, Nantes), this is done easily. As all the flights are managed by the same AU, the rest of the aircraft stay in the same sequence and get little delay.

If the Station Service is done by an airport service, all airlines are customers of the same provider. A negotiation may be done on the phone to swap priorities with another aircraft of the same AU. But this is very unusual as most of the time the Airline doesn't have any other flight to swap with if not in his Hub.

Lack of anticipation impact:

A last minute aircraft change from the OCC may impact the organisation of the various Service Providers. Experience shows that when anticipated, the preparation time for an aircraft turnover is about 25/35 min. As ground handling services are managed separately in a just-in-time strategy by independent outsourced service providers, any change has to be inserted by each actor on its own sequence list of aircraft to handle. As a consequence the global preparation time for the aircraft may be increased by 15 min.

A formal process allowing prioritisation at departure would help minimising the coordination aspects and reduce the impact of a change.

3.1.3 AUs Operating method

As operations are very different from an AU to another, it is not possible to summarize in this chapter all the operating methods for the variety of Airspace Users. This section intends to provide a global view of a medium size scheduled airline, to get a better understanding of the context in which the UDPP users operate.

⁹ from "Airport CDM Implementation: The Manual" v4 – April 2012

3.1.3.1 Flight Operations

3.1.3.1.1 Strategic phase

Schedule is built in the strategic phase. The programme is anticipated 5 years in advance with the commercial strategy, but the schedule is determined for the next 6 months period.

The optimum schedule is drafted, planning all the lines rotations taking into account precisely the station's turnaround with the minimum turnaround time for each aircraft type as a constraint input. The draft schedule is the best compromise between expected productivity and realistic prognostics.

The draft schedule is negotiated with Group / Alliance partners: airport slots are exchanged; seats on lines are shared ...

The final schedule for regular flights is negotiated at IATA conference, twice a year.

For one-off flights like charters, a IATA slot is asked independently from the conference.

The IATA time slots vary depending on airports (e.g.: EOBT+ 9 min at CDG). In case of missed slot on the day of operation, the Airspace User is expected to justify the reason, the cause being recorded.

3.1.3.1.2 Medium/Short Term Planning phase

In the Medium/Short Term Planning phase, at some FOC the Medium/Short Term Planning Dispatcher prepares flights for the next day. He anticipates problems and tries to fix solutions as far as he can.

- He coordinates by integrating all the constraints (COMM, TECH, CREW...) in order to ensure the realization of the flight program.
- Depending on the number of passengers, it may be necessary to change the aircraft type (smaller or bigger) or to cancel the flight or to lease an aircraft from another airline.
- He arranges rotations so as to bring a specific aircraft into maintenance.
- At some Aircraft Operators, the Medium/Short Term Planning dispatcher identifies on the next day flights a list of less important flights that could be cancelled in case of heavy problem.

In case of bad meteo or strike notice:

- The Medium/Short Term Planning dispatcher identifies a list of cancellable flights.
- He also checks the next day flights management: one crew and one aircraft allocated for a whole rotation to avoid complex situations.
- He delays maintenance on aircraft if possible.

3.1.3.1.3 Execution phase

The Execution Flight Dispatchers monitor and optimise the on-going operations. Their mission is to find immediate solutions to unexpected problems that might occur (technical failures, crew sickness, weather, industrial action, airport closure, etc.) and/or delays.

In case of unforeseen problem, they may have to arrange urgent maintenance on aircraft, to use a spare aircraft, to cancel flight and find accommodation for passengers, to cancel another flight instead and re-use the aircraft, to charter another airline (this list is not exhaustive).

They also look for alternative solutions in case of congestion, such as new trajectory, flight capping, or slot swapping.

The Crew Dispatchers have a similar mission, but they deal with crew problems: replacement of sick PN (Personnel Navigant), respect of cabin-crew and flight-crew duty time regulations and duty limits exceeds in case of delay, re-allocation of a crew on a different aircraft, taking into account specific qualifications, etc.

Any minute gained may have a positive snow-ball effect on following rotations.

3.1.3.1.4 Coordination for turnover at HUB Airport

At most CDM airports, steps of the aircraft turnover are outsourced in a just-in-time management. All actions are coordinated and monitored by the Flight Operations Centre.

The Airport Service Manager is in charge of the coordination of service providers for the following:

- Refuelling
- Drinking water filling
- Toilets emptying
- Luggage loading / unloading
- Fret loading / unloading
- Catering
- Cleaning
- Passengers transportation buses
- Passengers boarding footbridge stairs
- Boarding/ disembarkation of PRM (Passengers with Reduced Mobility)
- On-board documentation
- Aircraft guidance
- Aircraft positioning
- Luggage transportation

The Aircraft Operator is responsible for check-in and boarding of passengers.

The Aircraft Operator Station Coordinator spends about 1h per aircraft. He prepares documentation (e.g. luggage repartition loading plan), and coordinates all services on terrain. He estimates the most realistic time of aircraft readiness, and informs the FOC of the Estimated Departure time.

The Aircraft Operator Station Supervisor monitors field operations, and deals with unexpected situations such as transportation of a Cabin Crew from one aircraft to another in case of last minute change.

3.1.3.2 AU Flight Priority Management and Slot-Swapping

3.1.3.2.1 AU Flight Priority Management

Once a week, the Commercial Service establishes a list of priority flights in line with the AU commercial strategy.

On D-1, the Medium/Short Term Planning service establishes a priority flights list, taking into account the commercial priorities, in addition of other criteria such as number of passengers and receipt. Some Aircraft Operators built the flights priority list with the facilitation of an appropriate application (e.g. AF and KLM use the TFM-Traffic Flow Management- tool). The tool allows comparison between various scenarios and facilitates decision making.

On day of operation, the flight dispatcher monitors the traffic. He manages unexpected events and tries to keep in line with the provided priority list, taking into account additional criteria for decision making of prioritization. He may decide last minute changes such as to exchange aircraft fuselage, or swap flights CTOT.

On airport station, the Aircraft Operator Service Coordinator gets the priority flights list at the beginning of the day. But he has very few means of action. Management of ground services is compartmentalized, and the Coordinator has no hierarchical power on service providers.

At airport, the CDM cell only manages the ATC aspects. It doesn't take into account Station Services for the preparation of aircraft.

The chain of priority management is interrupted at Airport, at the last link of the chain.

3.1.3.2.2 Criteria of prioritization on Execution phase

On day of operations, the criteria taken into account in case of prioritisation are numerous, and the balance for decision is complex. Here is a non-exhaustive list of factors that are looked over when there is a need to cancel or delay a flight amongst two or more:

- Commercial priorities (IATA slots, new line on the market)
- Receipt
- Number of passengers
- Number of connections
- Rerouting possibilities for passengers
- Need for hotel
- Curfew at arrival airport
- Unaccompanied Minor (UM)
- If the flight transports crew to feed another flight (MEP: Mise En Place équipage)
- Duty time limits for crew
- Disabled passengers (PRM: Passengers with reduced Mobility)
- If there is a group (more difficult to reroute)
- Technical constraint on the aircraft (MEL): when an aircraft can only fly under specific conditions because of a technical temporary failure (e.g. if a light is missing in the passengers equipment → can only fly during daylight)
- If a maintenance is planned for an aircraft in the evening at a specific airport station
- If the flight feeds a special event at destination (Formula 1 Grand Prix, football cup, etc.)
- If the line is state-subsidized (e.g. touristic development of a region). OSP: Obligation de Service Public
- Presence of VIPs, journalists, press ...
- Impact of the flight on following rotations
- Meteo

If there is a need to delay/cancel a flight, the flight dispatcher checks all the here above criteria, and takes the less “bad” option. The balance upon various options remains on his own experience. He has full responsibility for decision.

3.1.3.2.3 Management of priorities on Medium/Short Term Planning phase

On Medium/Short Term Planning phase, it may happen that situation requires D-1 flights cancellations, for bad weather or strike reasons for example.

In case of strike notice, an authority may impose cancellations on the next day. In France DGAC announces a quota of compulsory cancellation (% of flights per time window), and asks AUs to provide a list of their cancelled flights.

The priority criteria taken into account in the Medium/Short Term Planning phase are simpler than on D-day of operations, because the passengers are still at home so impact is reduced at this stage. The earlier the passengers are informed about a cancellation or a flight delay, “the better” it is.

Amongst all the criteria filled for each flight, the main criteria taken into consideration at Medium/Short Term Planning phase for priorities/cancellations are:

- Commercial priorities (IATA slots, new line on the market)

- Receipt
- Number of passengers
- Number of connections
- In case the flight transports crew to feed another flight
- Do not cancel the same line several times in the day

3.1.3.2.4 AU use of ATFCM Slot swap

When there is a delay problem on day of operation, all is done to depart the flight on time as much as possible, with minimum impact on the rest of the airline flights.

In case of a delay with an allocated CTOT, the flight dispatcher will first request a slot improvement. If feasible, decision may be taken to impact negatively another flight doing a CTOT-swap.

There is very few potential for ATFM slot swaps on a normal day of operations.

There is an assumption that on imbalance days with severe delays, the CTOT-swap potential would be much higher. But as the Slot-swap procedure is not user-friendly, it takes an average of 6-7min to process a swap request. In a crisis situation, the flight dispatcher cannot afford 6 min multiplied by 10 demands: 1h in total only for swap requests whereas on crisis situation there is so much to do!

For the ATFM slot-swap to be used efficiently, automation and increased flexibility of the facilitation tool would be needed.

3.2 New SESAR Operating Method

Long in advance, Airspace Users (AU) schedule their flights to match their commercial strategy. But on Medium/Short Term Planning or Execution operations, high Demand Capacity Imbalance situations generate delay that impact Airspace Users operations. Sometimes delay is such that AUs have to cancel some of their flights.

However, from an AU point of view, all flights are not equal: some are fully booked whereas others aren't; some transport connecting passengers, some have VIPs on board the aircraft, some are important to get on time to respect IATA airport slots adherence, etc. Unfortunately, the AUs have very few means to react on disrupted situations delays and "choose" which flight they would like to get least/most impacted.

The UDPP (User Driven Prioritisation Process) aims to provide Airspace Users the possibility to play a role and keep their business priorities on track when operations are disrupted. UDPP will ensure that within the capacity limitations given, the maximum usage of the available capacity is being used, while taking Airspace User priorities into account.

UDPP-step1 aims to develop features providing AUs more opportunities and flexibility to rearrange their flight sequence by prioritising, swapping, or reordering.

- On departure congestion, the AUs priority demands will be taken into account and processed into the pre-departure sequence. UDPP is in essence a CDM-based process, all stakeholders contribute to the decision making process that ultimately produces a pre-Departure Sequence, respecting the Business Interest of the Airspace User.
- On en-route congestion, **the existing ATFM slot-swap will be extended to allow an enhanced service, providing a wider range of possibilities and increased flexibility.**

While performing flight exchanges, each flight is considered on a case by case basis, and AU has responsibility for deciding which flight needs prioritisation through swapping. No debate and no judgment will be made on how an AU decides which flight needs to be exchanged.

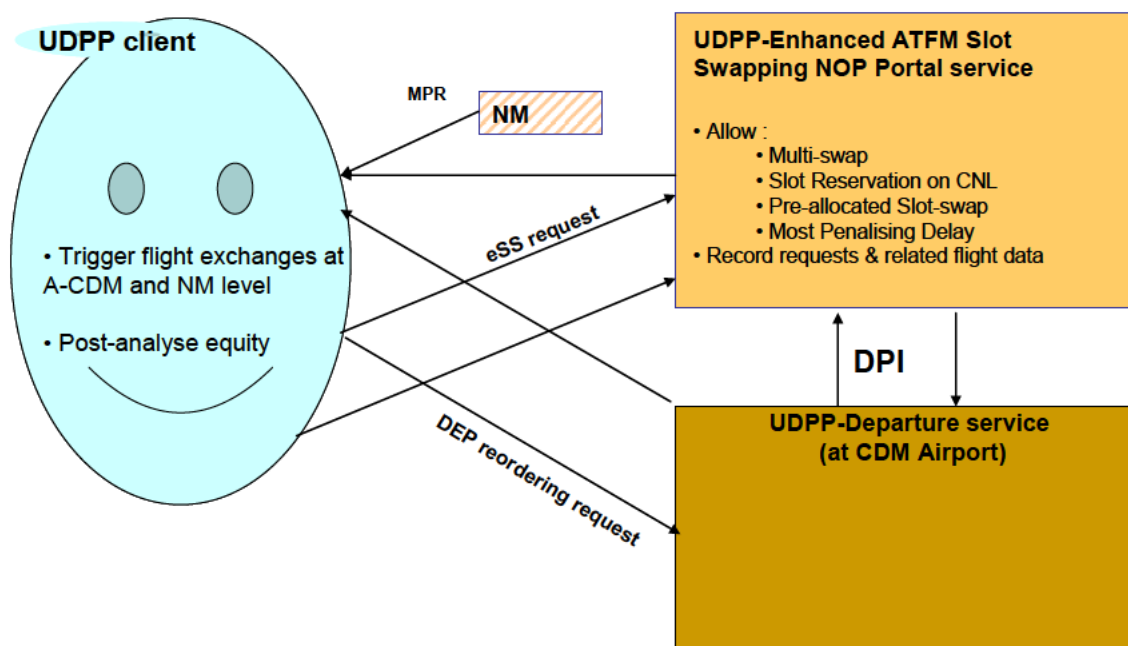

Figure 18: UDPP System Architecture

3.2.1 The Time-Reference swap concept:

3.2.1.1 The problem statement:

3.2.1.1.1 Issues of current ATFM Slot-swapping

The current slot-swapping of regulated flights is processed by swapping the CTOs (Calculated Time Over) of the two swapped flights. To prevent those CTOs to be recalculated by the allocation process algorithm CASA at next Revision Process, the exchanged CTO of the flight getting first is frozen.

This leads to several problems:

- **Loss of flexibility of CTOTs:**

When a slot-swap is performed, Flight B going 1st gets its new CTOT frozen.

If the proportion of frozen slots is too important, NM loses some flexibility to adjust CTOTs in case of regulation capacity evolution (deterioration / improvement). The consequence is that non-frozen slots will be moved up/down even more.

This issue could become critical if slot-swapping is popularized in a high proportion.

The system should ensure to keep swapped flights flexible, so that they can be moved in the flight list slots in case of regulation evolution.

- **Wrong statistics on NM performance:**

Some airlines use the slot-swap facility to delay the CTOT of a flight that cannot comply with its allocated CTOT. But in performance statistics, the delay allocated to 2nd flight is considered to be triggered by NM.

These statistics issues not reflecting reality could become even worse if slot-swapping is popularized in a high proportion.

In the case of a slot-swap, the extra delay allocated in the new CTOT of flight going 2nd should reflect that the Airspace User triggered the change and not be charged on NM.

3.2.1.1.2 Issues of departure reordering at CDM airport

The implementation of the CDM process in airports is guided by a standard to comply with, but each airport has a flexibility margin to integrate its specific constraints into this process. As a result, each A-CDM implements its own procedures, constraints and technical systems to build the Pre-Departure Sequence and the TSAT allocation algorithm.

E.g. one well-known difference is the choice to be taken by the airport to implement the FSFS (First Scheduled First Served) option, vs the FPFS (First Planned First Served). But many other variables are taken into account to build the Pre-Departure Sequence such as the number of runways (1 PDS for all Departure RWYs vs one PDS per RWY), the management of wake turbulence categories (to be included in the TSAT allocation algorithm vs managed by TWR controller with runway pressure), etc.

3.2.1.2 The Reference-Time swap solution

Any Slot allocation system (ATFM slots or A-CDM TSATs) is built taking a Flight Plans input list, processing this data with an algorithm, and providing a Sequenced list.

In the input list, the FPLs are collected and sorted with a Reference-Time. Depending on the system, the reference time may be the SOBT (Schedule Off-Block Time), the EOBT (Estimated Off-Block Time), the TOBT (Target Off-Block Time).

The output list provides the Slot Times. They are calculated in function of each flight's characteristics. They cannot be exchanged easily as the flights may not have the same constraints (e.g. different taxi-time).

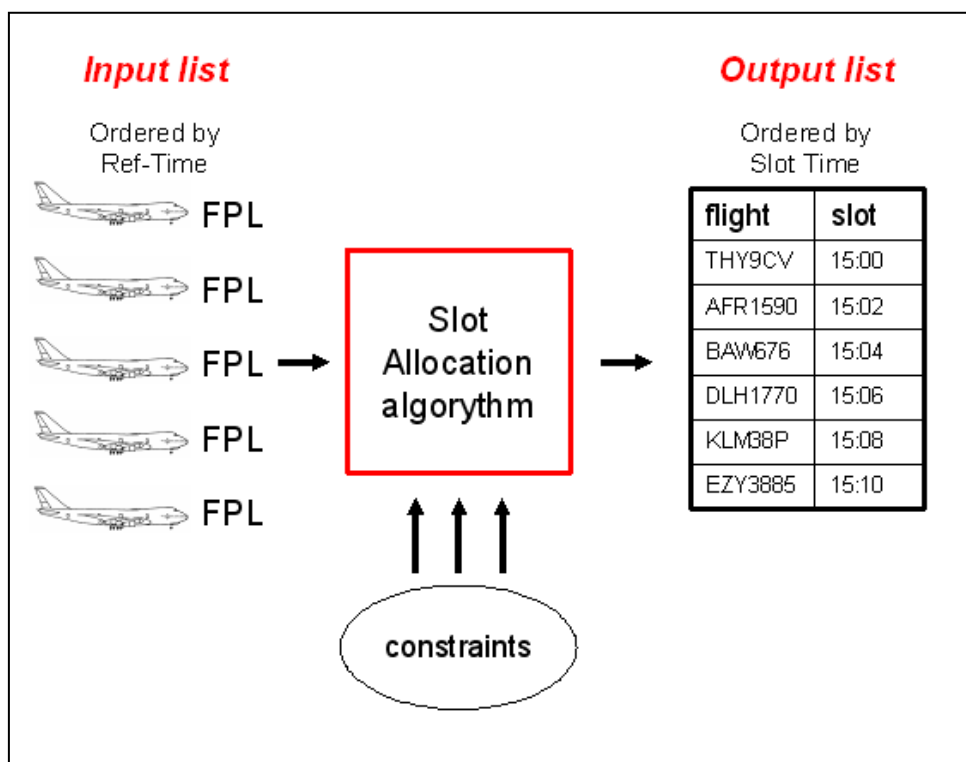

Figure 19: Slot allocation system.

Thus it is much more efficient to exchange places in the input list and process a recalculation, instead of exchanging places in the output list as currently executed in the current ATFM slot-swap process.

Let's take an example to image this:

Imagine you go to the cinema. You queue as there are a big number of persons. The First in the queue can choose his seat first, and so on. You are in the end of the queue; you don't have much choice, only a few spare sits here and there in the middle of rows.

You have a constraint: you broke your leg recently and you need to walk on crutches, and it's very difficult for you to reach the sit in the middle of the row. You want to swap with someone sitting on the edge. The first person you ask is very small; his constraint is not to sit behind a tall person and the free sit is not convenient to him either. Finding a partner to swap sits is not easy.

The solution would have been to agree to swap with someone when still in the queue.

Advantage n°1: This way, when it's your turn to choose the sit, you have the choice between all available sits without having to comply both with your own constraints and the constraints of your swapping partner.

Advantage n°2: if you go to a different cinema, you can still apply the same process, even if the cinema environment and configuration is different.

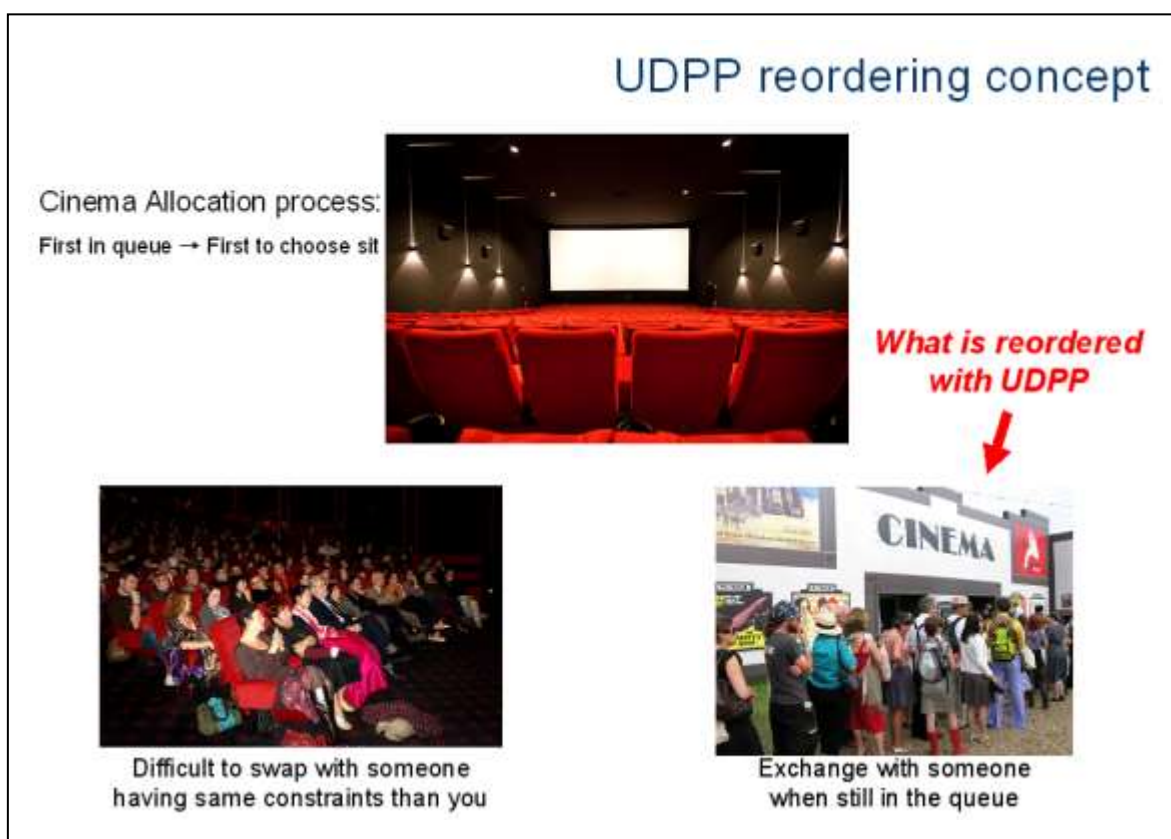

Figure 20: Metaphor for UDPP.

The same applies to the Slot allocation processes:

3.2.1.2.1 The Reference-Time swap of ATFM slots

The Network Manager receives all Flight Plans. Predicted Trajectories are calculated and monitored. When congestion is anticipated, a regulation is published subject to the Traffic Volume. A list of all Flights crossing the regulated Traffic Volume is built, sorted by Reference Time. The rule for the Reference-Time is the following:

Taking the EOBT (for flights departing from non-CDM airports) or SOBT (for flights departing from - CDM airports), the system calculates the expected Time at which the flight will enter the regulated traffic volume. This constitutes the Flight Reference Time at this point.

A “Regulation Reference-Time list” is defined, sorted by order of Reference-Time of the flights entering this regulated Traffic Volume. The CASA algorithm allocates a Calculated Time Over (CTO) taking all flights in their order of Reference-Time. Then the CTOT (Calculated Take-Off Time) is defined backwards.

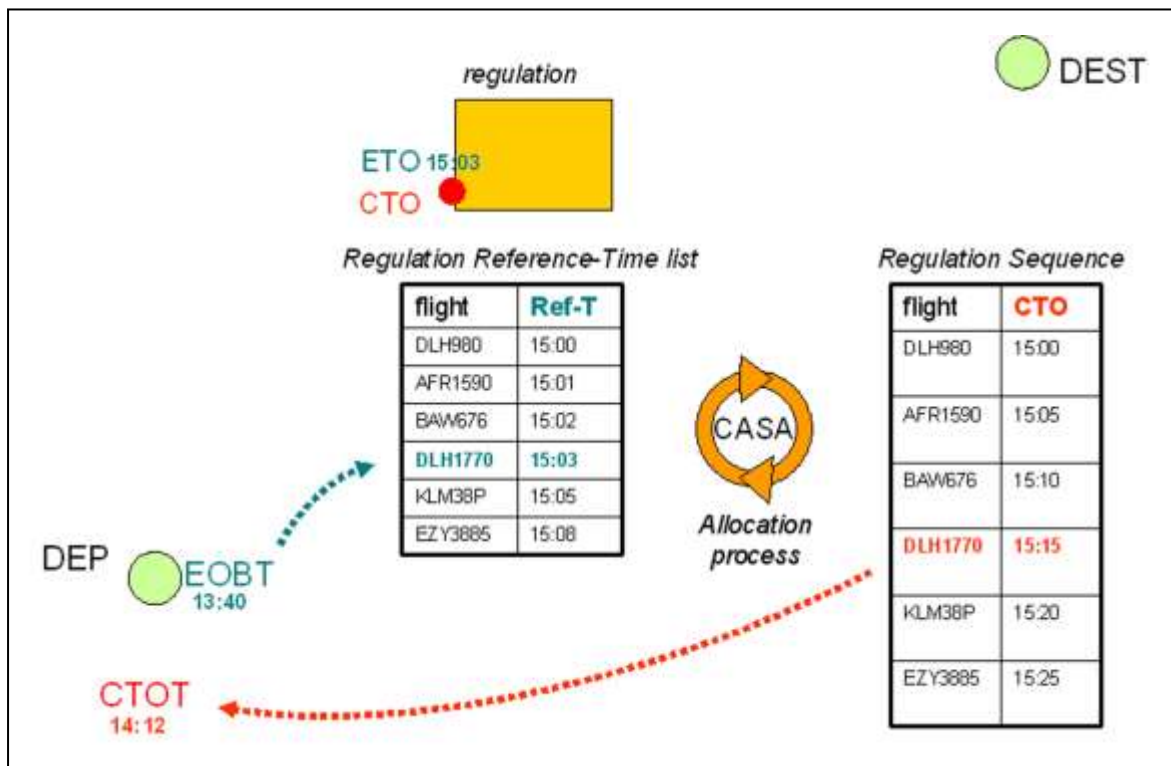

Figure 21: Introduction to a regulation's reference time list.

The UDPP Time-Reference ATFM slot-swap consists in exchanging the Flights in the Regulation Reference-Time list, which will lead to a recalculation of the Regulation Sequence.

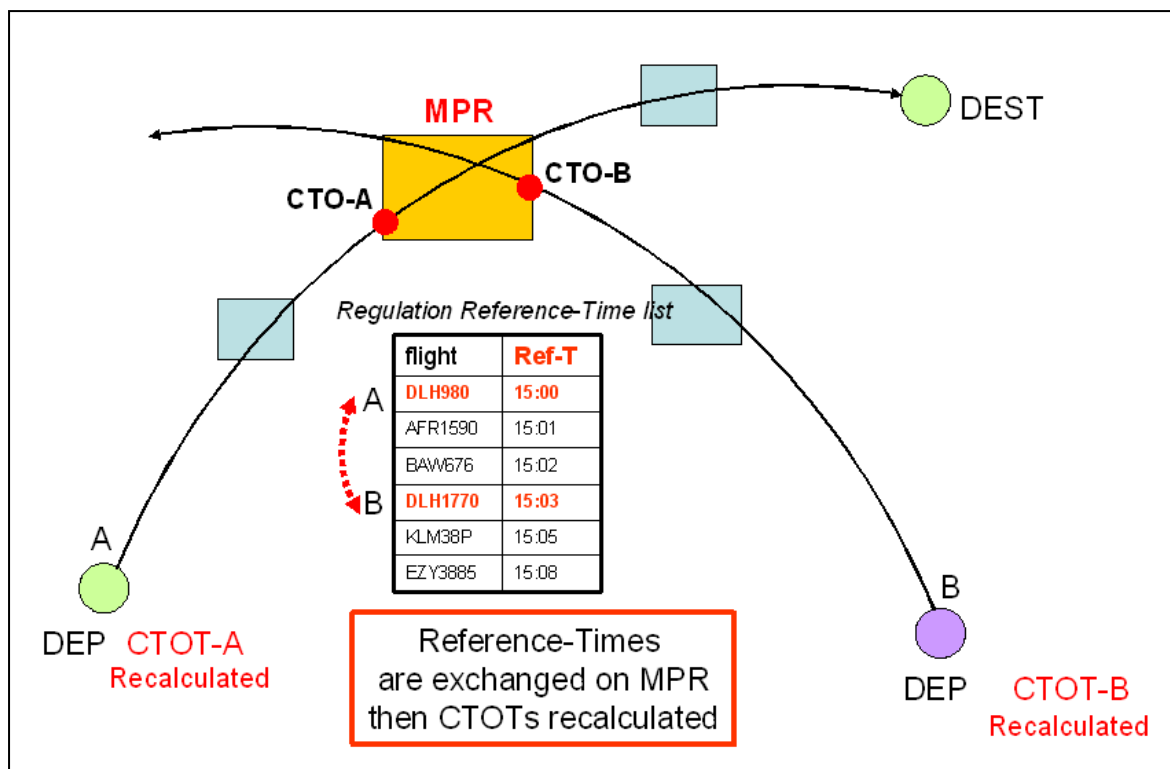

Figure 22: Reference times are swapped.

On a Network Manager perspective, the Time-Reference Swap allows:

- Safety of the Network as recalculation is reprocessed after the swap
- CTOT flexibility in case of regulation capacity evolution (*capacity reduction or improvement*)

On an Airspace User's perspective, equity is maintained for others with:

- CTOT stability: other flights' CTOTs remain unchanged as long as their recalculated-CTOT is within their initial-CTOT Slot Tolerance Window

3.2.1.2.2 The Reference-Time swap of A-CDM departure slots

At CDM airports, the principle remains the same. The Airport receives all the Flight Plans and sort them by Reference Time. Depending on how the CDM rules have been defined on implementation, the Time-Reference may be either the SOBT (Schedule Off-Block Time) or the EOBT (Estimated Off-Block Time). Whatever the rule for the flights' Reference Time, a Reference-Time list is built, that is processed by an algorithm taking into account all constraints to define the Pre-Departure Sequence, and then allocate the TSAT (Target Start-up Time) with a retro calculation of the taxi-time.

The UDPP Time-Reference Departure reordering consists in reprioritising the Flights in the Reference-Time list, which will lead to a recalculation of the Pre-Departure Sequence and a new TSAT allocation.

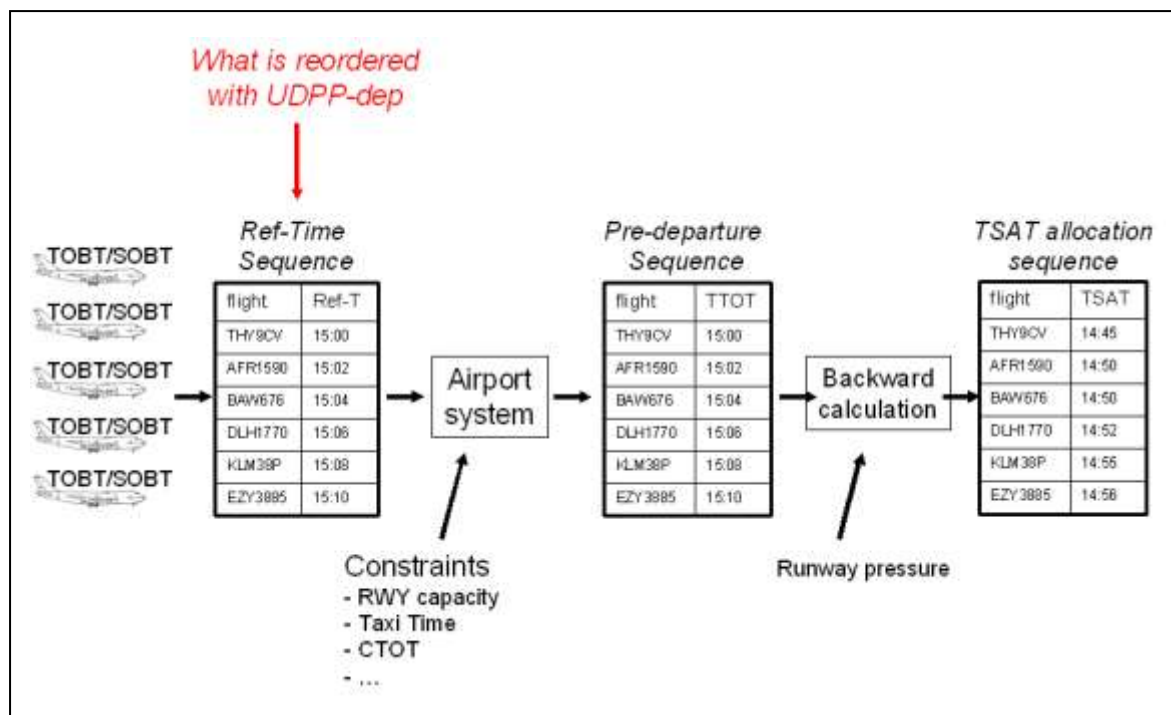

Figure 23: TSATs for regulated, swapped flights.

3.2.2 ATFM Enhanced Slot Swapping:

The current slot-swapping of regulated flights between AUs with commercial agreements on departure, on arrival, and en-route, will be extended to allow an enhanced service, providing a wider range of possibilities and increased flexibility. The enhanced Slot-Swapping (eSS) will include the development of new processes and services addressing multi ATFM slot-swapping, and the possibility to swap a pre-allocated ATFM slot with an issued ATFM slot of regulated flights.

The Network Management function will supervise the acceptance of ATFM slot-swapping requests.

3.2.2.1 ATFM slot swapping automation

As a pre-requisite to the development of extended functionalities, a number of evolutions of the existing ATFM slot-swap need to take place. As a matter of fact, a number of Airspace Users don't use the current Slot-swapping capability because of lack of User-friendliness. The NOP procedure is time consuming, which is an issue in disrupted conditions when Airspaces Users are so busy solving problems. Some additional tools and automation should be implemented to ensure the UDPP-Step1 enhanced Slot-Swapping features being used at their best efficiency.

The Slot-swapping upgrades described below are to be taken under responsibility of NM/NTS. They only address HMI issues, and are NOT considered to be Research Concept.

3.2.2.1.1 Slot-swapping search & display tool

As explained in the Current NM Operations section of this document, various constraints are applied to determine if a flight is swappable with another. Some are visible to AUs (e.g. Most Penalising Regulation), but some are not visible to AUs (e.g. frozen slot, overload forced slot). Therefore it is difficult for AUs to select swappable flights as they are not aware of all the information.

In addition to that, when an AU asks for a slot-swap in the NOP e-helpdesk, an NM operator has to deal with the demand and to reject it if the criteria are not valid; this is a waste of time and it could have been avoided.

In order to avoid lost time because of invalid slot-swap demands, the system should provide to AUs a mean to display swappable partner flights for any selected flight.

1. Procedures:

AU gets the possibility to visualise easily all potential Slot Swapping Partners for a selected flight, within a specified time window. For a selected flight on the flight list display, a list of potential Slot Swapping Partners shall be displayed, taking into account constraint criteria and rules applying to the slot-swap procedure (Refer to Appendix B.1 NMOC Slot-Swapping rules and constraints, page 131) . The Airspace User will have the choice to view all possible swap partners, or to filter the potential candidates within its own airline, within its Group, or within a slot-swap Commercial Agreement Group. If AU wants to see all swappable partners even outside Commercial agreement, it should not select any filtering option.

2. Optional features in addition to the nominal features:

None.

3. Required inputs and outputs:

As an input, the AU needs to select a flight for which a CTOT is allocated.

As an output, the list of potential Slot Swapping Partners is displayed, taking into account all constraint criteria and rules restricting slot-swap possibilities.

4. Triggering events:

An AU wants to analyse the slot-swapping possibilities for one of its flights.

5. Actors:

AU to select a flight for which a CTOT is allocated.

6. Automatic actions:

The system processes the analysis and displays the list of swappable partners.

7. Sequence of services:

None.

8. Additional features:

None.

9. Requirements:

For a selected flight on the CHMI, a list of potential Slot Swapping Partners is displayed, taking into account all constraint criteria and rules applying to the slot-swap procedure.

The AU will have the choice to view all possible swap partners, or to filter the potential candidates list within its own airline, within its Group, or within its slot-swap Commercial Agreement Group.

AUs preferences:

Flights detected to be in the 'TTOT CTOT convergence phase' when all the following conditions are met:

- The flight's CDM status is TARGETED,
- The flight's REA status is set by NM ETFMS
- The flight's CDM no slot before is set

This state occurs when the CDM airport has transmitted a T-DPI for the subject flight with a TTOT that is before the CTOT STW. During this period the CDM airport may repeatedly send new TTOTs.

This is typically the case at LFPG where TTOT increments of 5 minutes are received, moving the flight progressively towards the CTOT STW.

3.2.2.1.2 One-click Slot-swap request

The CHMI offers no possibility to process a CTOT-swap demand. This has to be done via the NOP E-Helpdesk only. It would be very time-saving to envisage the possibility to implement a quick and easy slot-swap request device via the CHMI or NOP portal flight list.

10. Procedure:

1- Request issuance: From the NOP/CHMI Flight List and/or the *Slot Swapping Partners Display* (described in *Slot_swapping_partners_display*), an Airspace User should be able to select one partner from this swappable flights list in order to request a slot swap. The request process should be simple, minimum time consuming, user-friendly, directly accessible from the swappable flights list. This function already exists in CHMI, but only for TWR in the CHAMAN procedure. Therefore it could be used and enhanced for Airspace Users use as well.

2- Request confirmation: The Airspace User possibly gets a "simulation" of the slot-swap effect: as in reality the CTOs (Calculated Time Over) of the two flights are exchanged, there is a retro-effect with a recalculation of what would be the new CTOTs for the 2 flights. The AU gets notified of what would be the new CTOTs of the 2 flights before actually confirming his request. (already in NID). Then the Airspace User has the choice to confirm or abandon its request.

3- Automatic assessment of request: The system could automatically validate the request by assessing the impact on the network. In case no negative impact the system would automatically accept, in case of negative impact the system would send the request to an operator (via E-help desk) for a deeper analysis. [Automatic analysis of the new CTOTs was already implemented in the CHAMAN procedure]. This automatic assessment should be deactivable.

11. Optional features in addition to the nominal features:

None.

12. Required inputs and outputs:

As an input, an AU needs to select two flights for a slot-swap request. As a 1st output, the system provides an estimation of what would be the new CTOTs of the two flights if swapped. As a 2nd output, the system provides the automatic acceptance or rejection (or need for manual processing) of the slot-swap demand in function of impact on the network analysis.

13. Triggering events :

AU detects a need for a slot-swap.

14. Actors:

AU to trigger the slot-swap request.

15. Automatic actions:

- The system should analyse the impact on the network and provide automatic response: acceptance/ rejection/ transferred for manual processing.
- However low priority requests should have a latest response time so that these will not remain at the end of the queue forever. The latest response time may depend on length of the queue.

16. Sequence of services:

None.

17. Additional features:

None.

18. Requirements:

Simplify the slot swap request by providing AUs the possibility to perform a slot-swap request with minimum effort from the CHMI, using automation mechanisms.

Provide AUs a simulation of what would be the new CTOTs of the two flights, giving the AU the possibility to confirm or cancel his request before actually processing it.

Implement an automatic analysis of the impact on the Network, providing as an output an automatic response: acceptance/ rejection/ transferred to an operator for manual processing.

3.2.2.2 Multi-swap of ATFM Slot Swap

Two types of multi-swap are described. **Type 1** swapping permits the same flight to be swapped more than once in different (i.e., separate) swap requests. **Type 2** swapping permits the same flight to be swapped more than once in the same request. The two types are described separately below.

3.2.2.2.1 Independent Multi-swap ('Type 1')

This feature develops the possibility for an AU to swap the same flight several times independently. This flexibility takes sense in a degrading congestion situation creating instability of the regulation CTOs (Calculated Time Over), e.g. the weather is deteriorating, creating revisions in the slot allocation sequence with increased delays.

Today, an AU has the possibility to swap 2 flights only once, then swapping again one of the two with another flight is forbidden. But in some cases the AU would need more flexibility to rearrange its flight prioritisation because of degrading conditions (e.g. weather evolution, etc.).

The multi-swap will enable the AU to review and reprioritise its flights several times as the congestion situation is evolving and getting worse. It will also bring the possibility to improve one specific flight and cascade others down in the list.

NOTE:

The actual system could allow for multi-swap on a technical point of view, but the procedure described in the ATFCM Operations Manual edition 16.0 doesn't allow multi-swap on a process point of view. · ["Only one swap per flight shall be accepted, except critical events (CHAMAN)."]

The reason why multi-swap is not authorised is to prevent from cheating by creating ghost flights. E.g. an AU may file a FPL for a flight that not exists and then swap it with the delayed one in order to get minimum delay, and then cancel the ghost Flight Plan.

To avoid such a situation, before validating a ATFM slot swap, the NM controller checks if the candidates flights have already been swapped once. If so, it is indicated in the system with a "flag".

Strictly speaking, an AU may cheat creating a ghost flight even with simple swap procedure. Un-authorising multi-swap only avoids it to happen too much.

The Extended Flight Plan developed by project 07.06.02 shall solve the ghost flights issue by performing a cross-check with IATA airport slots.

Cheating issue:

It is agreed that an Airspace User can use ATFM slot-swapping capability to minimise loss in case of cancellation, by first swapping two flights and then cancel the second one.

However, this should not become an business strategy. There is a risk that Airspace Users could use the Multi-swap capability as a strategic mean to cascade down flights as much as they can by delaying the flights virtually instead of cancelling them.

To prevent from abuse by Airspace Users, a counter shall be implemented to record the number of times a flight has been swapped.

Slot-swaps counter: A counter shall be implemented to record the number of times a flight has been swapped. Today, a count set to 1 already exists in the form of a flag attached to the flight information in the ETFMS. The slot-swaps counter will extend this information for Multi-swap.

For each flight in the flight list, the flight's counter will be incremented each time the flight's ATFM slot is swapped. It should be highlighted that even flights not regulated by a CTOT but having a "Most Penalising Delay" at their Departure CDM Airport could be potentially swapped (described in CR - UDPP "Most Penalising Delay"), thus they will need their Counter to be incremented as well.

Slot-swaps Limitation parameter: To prevent risk of abuse, the number of slot-swaps will be limited against a maximum value. This maximum number of authorised swaps (MAX SWAPS) will be used in the Slot-swapping Partners Display" tool, to filter flights whose slot-swaps counts < MAX-SWAPS.

The maximum number of swaps authorised (MAX SWAPS) will be implemented as a changeable parameter. By default, it will be set at 3.

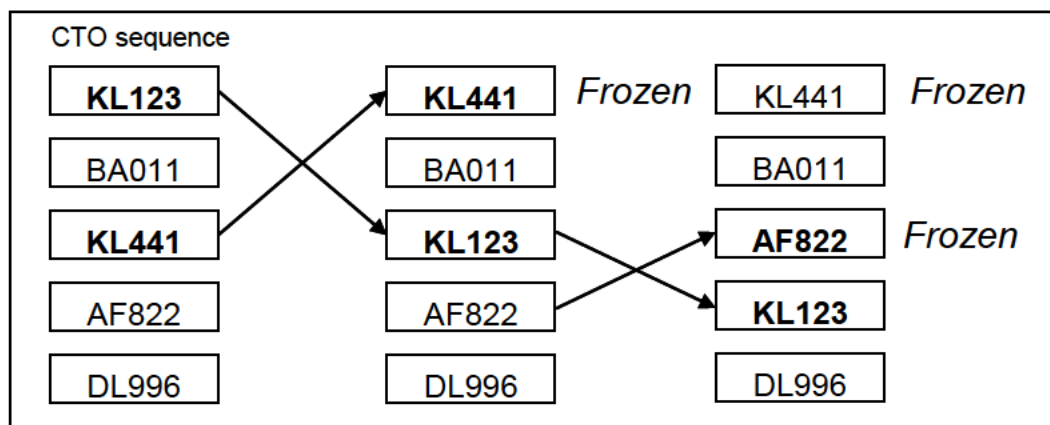

Figure 24: Description of the Multi-swap of ATFM Slot Swap ('Type 1').

19. Procedure:

The procedure for swapping flights already exists but it should be allowed to swap one flight several times.

20. Optional features in addition to the nominal features:

This process needs no additional feature to the nominal one.

21. Required inputs and outputs:

No new types of inputs required. The required inputs are similar to those of a standard ATFM slot-swap, so the outputs.

22. Triggering events:

No different from the current ATFM Slot Swap request.

The multi-swap shall be operated as normal slot-swaps, successively in the order of requests.

A multi-slot swap is triggered the same way as a standard slot-swap: the AU, analysing its flight operations planning, identifies 2 flights for a suitable ATFM slot-swap and initiates the request to NM. Then, based on his planning evolution, he may decide to perform a new slot-swap request including one of the previously swapped flights.

23. Actors:

No different from the current ATFM Slot Swap request.

24. Automatic actions:

No different from the current ATFM Slot Swap request.

25. Sequence of services:

It shall be the responsibility of the airspace user to manage his multi-swap demands one after the other. It is advised that an AU should NOT request a second slot-swap for a flight as long as the previous demand is still under treatment.

If this recommendation is not followed, the AU takes entire responsibility of action in case the first slot-swap demand is rejected.

However this risk will be minimised with the implementation of the "Slot-Swap demand automation" that will provide immediate feedback (acceptance or rejection) to the AU slot-swap request.

26. Additional features:

None.

27. Requirements:

The ATFM User Manual needs to be updated to allow for multi-swap.

3.2.2.2.1 One-request combined Multi-swap ('Type 2')

This feature develops the possibility for an AU to submit a request that is combining 2 or 3 swaps in only one action.

This flexibility takes sense in a highly degraded situation creating huge delays that are difficult to recover with only one single slot-swap:

- This feature develops the possibility for an AU to catch up 'on-time' by combining several slot-swaps whereas a single slot-swap would not be sufficient to recover from the total delay.
- This feature develops the possibility for an AU to spread the delay of a flight over 2 or 3 flights, avoiding to impact too heavily one single flight.

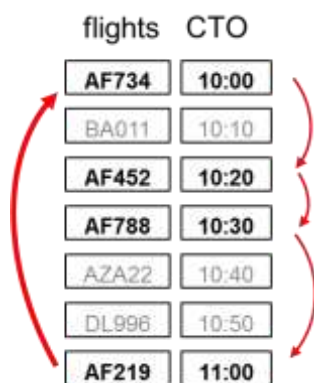

Figure 25: Description of the 'Type 2' multi-swap.

The Slot-swapping Tool will calculate combinations of flights that can be swapped all at once to reorganise the AU's flight sequence according to its business needs.

The "one-request combined multi-swap" will enable the AU to review and reprioritise several flights simultaneously. It will also bring the possibility to improve one specific flight and cascade others down in the list.

The main difference with the independent Multi-swap is the possibility to send the combination of swaps all in one go, within single E-Helpdesk request.

The benefit of having a single request combining several slot-swaps is that it can be accepted or rejected all at once. In this case, the Airspace User submitting a 'one-request combined multi-swap' establishes a strategy that will provide benefit ONLY IF the strategy is applied entirely. The Airspace User is not interested in having only half of his strategy implemented (e.g. only the first slot-swap was accepted, then 2nd slot-swap was rejected).

This feature should be implemented as an addition to the "Independent Multi-swap" (i.e., Type 1) feature. In consequence, the "slot-swap counter" as well as the "Slot-swaps Limitation parameter" are required.

Combined slot-swaps NID:

Today, the NID (Network Impact Display) tool allows the NMOC officer to assess the impact of one slot-swap only at a time. To prevent from having half of the request being executed, and then the second part of the request being rejected, an extended NID functionality will need to be developed. To implement the “one-request combined multi-swap”, the NID will have to allow the NMOC officer to assess the combination of slot-swaps all simultaneously and take the decision whether to accept or reject the submitted request.

28. Procedure:

The procedure for swapping flights already exists but it should be allowed to swap several flights in one request.

29. Optional features in addition to the nominal features:

This process needs no additional feature to the nominal one.

30. Required inputs and outputs:

No new types of inputs required. The required inputs are similar to those of a standard ATFM slot-swap, so the outputs.

31. Triggering events:

No different from the current ATFM Slot Swap request.

The ‘combined multi-swap’ shall be operated as one request, i.e. assessed then accepted / rejected.

A combined multi-slot swap is triggered the same way as a standard slot-swap: the AU, analysing its flight operations planning, identifies a subject flight he wants to improve or delay. Then, using the USST (UDPP Slot-swapping Tool), he searches for a suitable ATFM slot-swapping combination and initiates the request to NM.

32. Actors:

No different from the current ATFM Slot Swap request.

33. Automatic actions:

No different from the current ATFM Slot Swap request.

34. Sequence of services:

The “combined multi-swap” request is to be submitted in one-go to the NOP E-Helpdesk, using the ‘one-click request’ feature.

NMOC assesses the combination of slot-swaps simultaneously, accepting or rejecting the whole package at once.

35. Additional features:

None.

36. Requirements:

The ATFM User Manual needs to be updated to allow for multi-swap.

3.2.2.3 ATFM Slot Substitution on Cancellation

Summary:

Develop the possibility for an AU of substituting the ATFM slot of a cancelled flight for another flight (ownership).

When cancelling a flight, AUs wish to keep the allocated slot for another departure: this is “substitution”. Nowadays, the only possibility is to swap the two flights, and then cancel the second flight.

The Airspace User loses a number of possibilities, as NMOC assesses the impact on the Network of both flights, even in the case that the subject flight is going to be cancelled.

This feature provides the AU more possibilities for managing the cancellations. The Airspace User will get a better rate of acceptance in case the subject flight is impacted by several regulations, compared to today.

Constraint: the replacing flight should have the same Most Penalising Regulation or Most Penalising Delay.

The equity perspective in case of ATFM Slot ownership remains unchanged in comparison with “Swap first then Cancel”. In the later, the airline keeps its slot until it knows which flight to swap with. Then it requests the swap. The second flight gets first with a forced-slot status, and the AU cancels the other one. In case of slot-substitution, the Airspace User gets more chances to see its request accepted because the impact on the Network of the cancelled flight can be ignored by NMOC. It makes no difference between the 2 procedures with regards to frozen-slot.

On the lost-slot risk, this new functionality would have no impact either. With current procedure (swap first, then cancel), if the slot-swap is asked too late or rejected, there is a risk that CASA cannot reallocate the slot. With the slot-substitution functionality, the slot will be filled instantly.

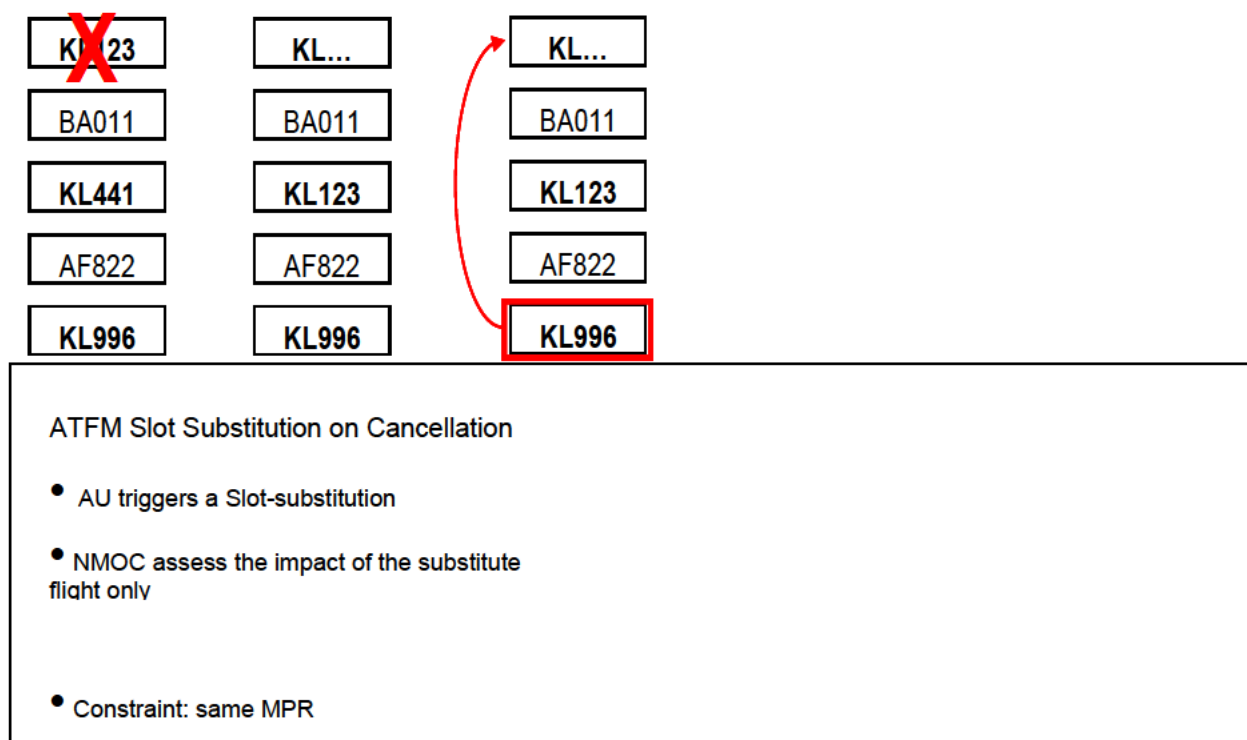

Figure 26: Principle of ATFM Slot Substitution on Cancellation.

37. Procedure:

Current AOWIR procedure allows the assessment of the Impact of the Network simultaneously for the 2 flights to be swapped.

The new procedure shall allow the assessment of the Impact on the Network to be analysed for the substitute flight only , having the same Most Penalising Regulation.

38. Optional features in addition to the nominal features:

None.

39. Required inputs and outputs:

The required inputs are the cancelled flight, and the substitute flight.

40. Triggering events:

The trigger will be acted by AU in 2 simultaneous steps:

- Cancel a regulated flight
- Designate a substitute flight, or release ownership of the slot if information is known that there is no possible substitute flight.

41. Actors:

AU detects a need for ATFM Slot Substitution on Cancellation.

42. Automatic actions:

- When the AU triggers the ATFM Slot Substitution on Cancellation, the replacement analysis and acceptance/rejection will be processed automatically by NM system on the same parameters/constraints as the slot-swap request.

43. Sequence of services:

None.

44. Additional features:

This process should need no additional feature. At CDM airport level, it should be processed the same way as a normal slot improvement in the current procedure.

Technically, at the time the 1st flight is cancelled, the DEP airport receives the CNL message and the flight place in the pre-departure sequence is released: TSAT is reallocated by the system to other flights in the pre-departure sequence.

When the substitution flight is designated, it receives a new CTOT. This CTOT is taken into account by the APT CDM process for TSAT allocation, the same way as a normal CTOT improvement.

45. Requirements:

The new procedure shall allow the allow NMOC to assess the Impact on the Network of the substitute flight only..

The cancellation process from the airline HMI should be a special cancellation process, to be handled automatically just after the substitution has been executed by NMOC.

3.2.2.4 Pre-allocated Slot Swap

Develop the possibility for an AU to swap a regulated flight being in the slot-allocated status with another flight still in the pre-allocated status.

The flying time before entering a regulation may be very long (long haul with a regulation close to arrival), or very short (short shuttle flight). As the CTOT is issued 2h prior to EOBT, the first flight is already airborne when the 2nd flight gets its CTOT issued, and no slot-swap was possible.

The pre-allocated ATFM slot-swap will allow the Airspace User to request the slot-swap even if 2nd flight CTOT is not yet in 'issued state', so that its CTOT can be swapped with the first flight.

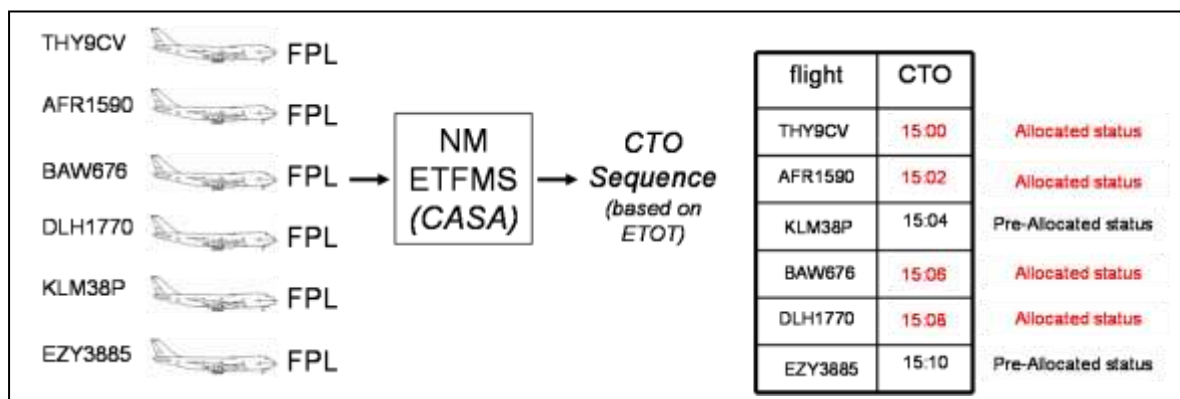

Figure 25: Explanation of pre-allocated swapping.

Fairness Issue:

Today, the CASA system is designed to allocate the first available slot closest to Reference Time (most often ETO). CASA algorithm looks for the first available slot in the sequence from Reference Time.

Once CTOTs have been issued (Allocated slot status), then CTOTs remain fixed unless there is a high capacity degradation. This prevents AUs from instability of CTOT.

However, before being issued (pre-allocated slot status), CTOTs are still subject to change (improvement/delay). If the flight is delayed by swapping, CASA will process the algorithm automatically and allocate again the first available slot with regards to the flight's Ref Time. This means that for the swapped flight going second, the system will reallocate a new CTOT, by identifying any gap earlier in the pre-sequence.

On a fairness point of view, if an AU initiates a slot-swap, it agrees to prioritise one flight against delaying another one: the flight going second should get extra delay. But the way CASA algorithm is designed leads to the situation that although the Airspace User decided to swap this flight and agreed to get the extra delay, the flight could be improved by CASA, to the detriment of other flights.

CR_035232 has been raised to request implementation of a feature that will help to allow for pre-allocated slot swaps. [CR_035232 – Slot-swap – prevent that delayed flight is automatically advanced (within FB619)].

46. Procedure:

The ATFM Slot Swapping procedures should be updated to allow for swapping of pre-allocated flights.

47. Optional features in addition to the nominal features:

None.

48. Required inputs and outputs:

The CHMI flight list should offer the possibility to display pre-allocated slots to AUs, in a recognisable and different way from allocated slots.

49. Triggering events:

The AU may trigger a slot-swap with pre-allocated slots flights.

50. Actors:

No different from the current ATFM Slot Swap request.

51. Automatic actions:

The pre-allocated slots flights appear in the list of possible swap-partners as described in feature above.

52. Sequence of services:

Not applicable.

53. Additional features:

None.

54. Requirements:

The pre-allocated slots flights appear in the list of possible swap-partners as described in feature above.

3.2.2.5 Most Penalising Delay

This capability allows considering in a global way all delays along the flight's trajectory, including CDM APT at departure.

It develops the possibility to take into consideration the CDM airport delay in the slot-swapping process.

Nowadays, congestion at non-CDM airport is managed via a regulation process, allocating a CTOT to flights. If the delay at the airport is the Most Penalising Regulation, AUs have the possibility to use the slot-swapping process.

At CDM airports, congestion is managed internally within the pre-departure sequence, and regulated flights can only swap slots sharing the same Most Penalising Regulation. Even if the delay at the airport is the most penalising for several flights, the AU doesn't have the possibility to swap regulated flights in the NM system as their ATFM slot is calculated in function of published regulations. Taking into consideration of the CDM airport delay will increase the slot-swap possibilities for AUs.

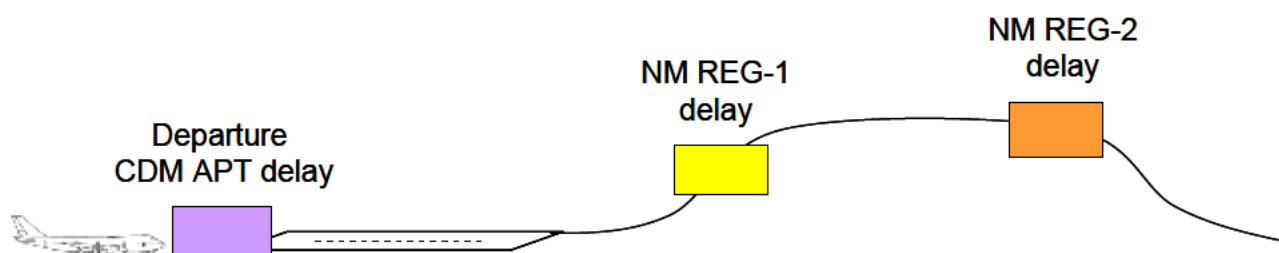

Figure 27: Principle of the Most Penalising Delay.

55. Procedure:

The airport ATC-ground delay (from dpi messages) will be taken into account as a factor in the slot-swap acceptance analysis. A CDM airport ATC-Ground delay shall be considered as the Most Penalising Delay when ATC-ground delay > ATFM delay for the flight to be swapped.

At NMOC side it should be possible to enable & disable this feature.

56. Optional features in addition to the nominal features:

None.

57. Required inputs and outputs:

The NMOC Flow controller should be able to enable & disable the feature.

Airport delay will be an input into NM system.

58. Triggering events:

The AU may trigger a slot-swap between flights having the same Most Penalising Delay.

59. Actors:

NMOC flow controller & ATC/TWR supervisor.

60. Automatic actions:

The airport delay will be computed and taken into account as a factor in the slot-swap acceptance analysis.

61. Sequence of services:

Not applicable.

62. Additional features:

None.

63. Requirements:

A procedure must be agreed between NMOC and CDM airport which contains the conditions under which the feature could be enabled and how it can be requested.

The "Most Penalising Delay" notion will be introduced into NM. The system may either consider it the same way as a regulation, or insert it as a new device.

The Most Penalising Delay will replace the Most Penalising Regulation in the NM slot-swap acceptance rule.

3.2.2.6 Enhanced Slot-Swapping Summary Table

The main points of the Enhanced Slot-Swapping concept are summarized in the following table:

| | |
|--|--|
| Multi-swap of ATFM Slot Swap | A regulated flight can be swapped several times Process: Repetition of simple ATFM slot-swap |
| One-request combined Multiswap | A combination of up to 3 swaps can be sent in one-go to NMOC, to be either executed or rejected totally |
| Pre-allocated slot-swap | A regulated flight can be swapped with a pre-allocated slot |
| Most penalising delay | All delays along the Flight's trajectory are considered , including CDM APT at departure Takes into account departure CDM APT delay to determine the Most Penalising Delay Would allow to swap regulated flights with \neq MPR in case of heavy CDM APT congestion |
| ATFM Slot Substitution on Cancellation | AU cancels a regulated flight, while designing a substitute flight |

Table 5: Enhanced Slot-Swapping summary.

At the time of writing all Step 1 validation activities have ceased. The 'pre-allocated slot swapping' and 'one request combined multi-swap' are not in SESAR solution #56. They have been transferred to NM for further development, validation and deployment. The 'most penalizing delay' feature has been rebadged as OI step AUO-0108 [10] and will be validated in SESAR2020.

3.2.3 UDPP – Departure:

UDPP-Departure features implemented in A-CDM airports will allow the Airspace Users to change the priority order of flights, in the pre-departure sequence.

Changes in the pre-departure sequence will be communicated to the Network Management function through DPI messages.

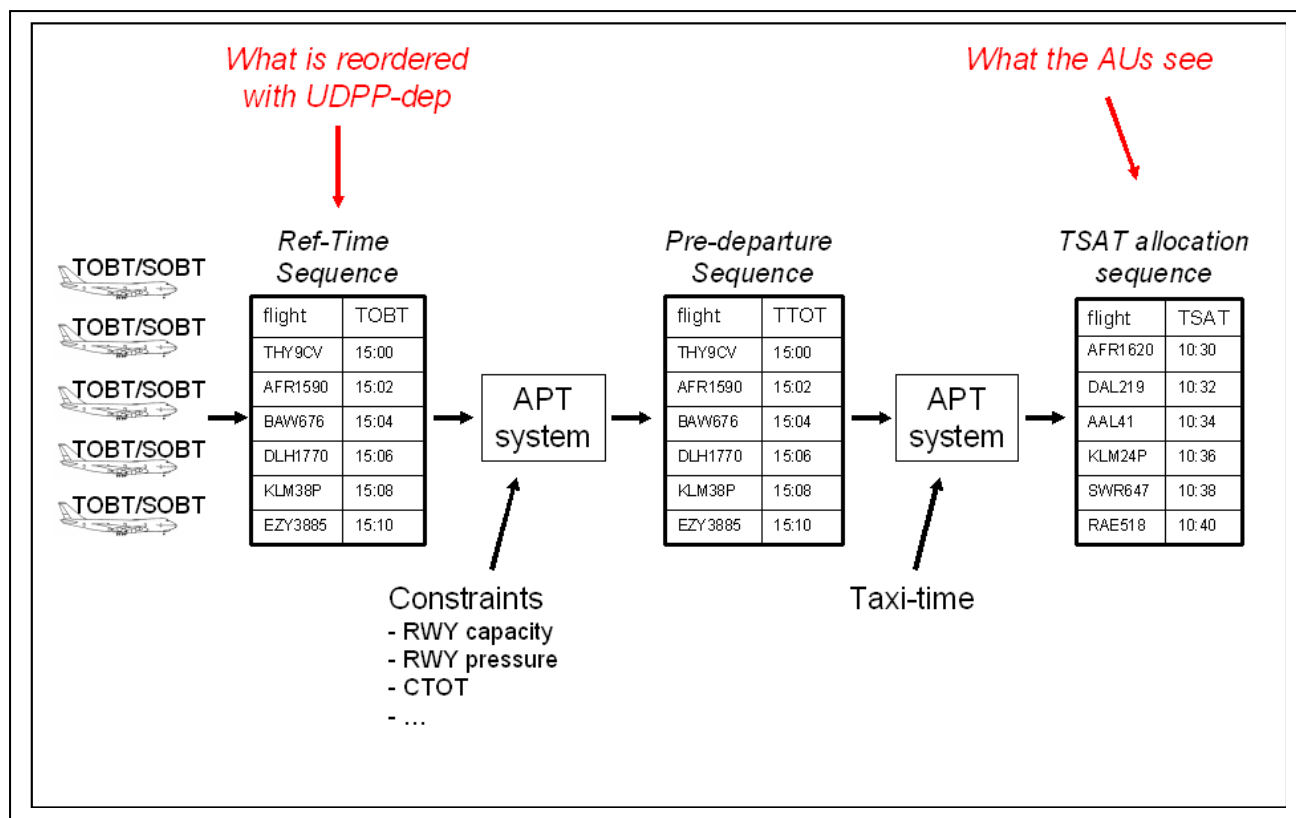

Figure 28: Explanation of the UDPP Departure Concept.

3.2.3.1 Departure Reference-Time Reordering

Develop the possibility for an AU to reorganise /reprioritise his flights in the pre-departure sequence at CDM airport level. The Departure Reference-Time Reordering will allow the airspace User some flexibility to rearrange its flight operations according to its business requirements.

The Airspace User needs to identify certain “sensitive” flights for which a local constraint at Departure Airport would induce important delays. If transferred to another less sensitive flight, those delays could be minimized.

On a selected number of flights identified by the airline, the initial order for departure must be re arranged by the airline in order to preserve those sensitive flights.

This upgrade would allow redistributing delays due to local airside constraints on a list of flights depending on their sensitivity.

In the case of regulated flights, either in the slot-issued status, or in the pre-allocated slot status, the process will be designed in line with NM processes.

This feature will provide the Airspace User the possibility to reorder the priorities of its departures at a specific airport. Then the CDM airport system will recalculate the departure sequence, taking into account the airspace user’s indicated priorities. However reordered flights will not be able to depart ahead of their Scheduled departure time (SOBT).

Example:

For instance, when one AU on his HUB has delayed a peak of medium haul departures because of operating reasons, the FOC could prefer to let these flights depart after the next long haul departure wave, in order not to penalize the long haul departures. This will need to exchange the priorities

between the long haul and the medium haul flights. Otherwise, the PDS will position the medium haul flights departures before the long haul flights, and thus delay the long haul flights.

Priority for treatment:

To allow implementation in any CDM, the concept is based on the priority in the treatment process. Times in the PDS sequence are not exchanged as such. The priority of treatment is exchanged. This means that the first in the list “chooses” its slot first, and gets more choice to accommodate a minimized delay departure time than further in the list.

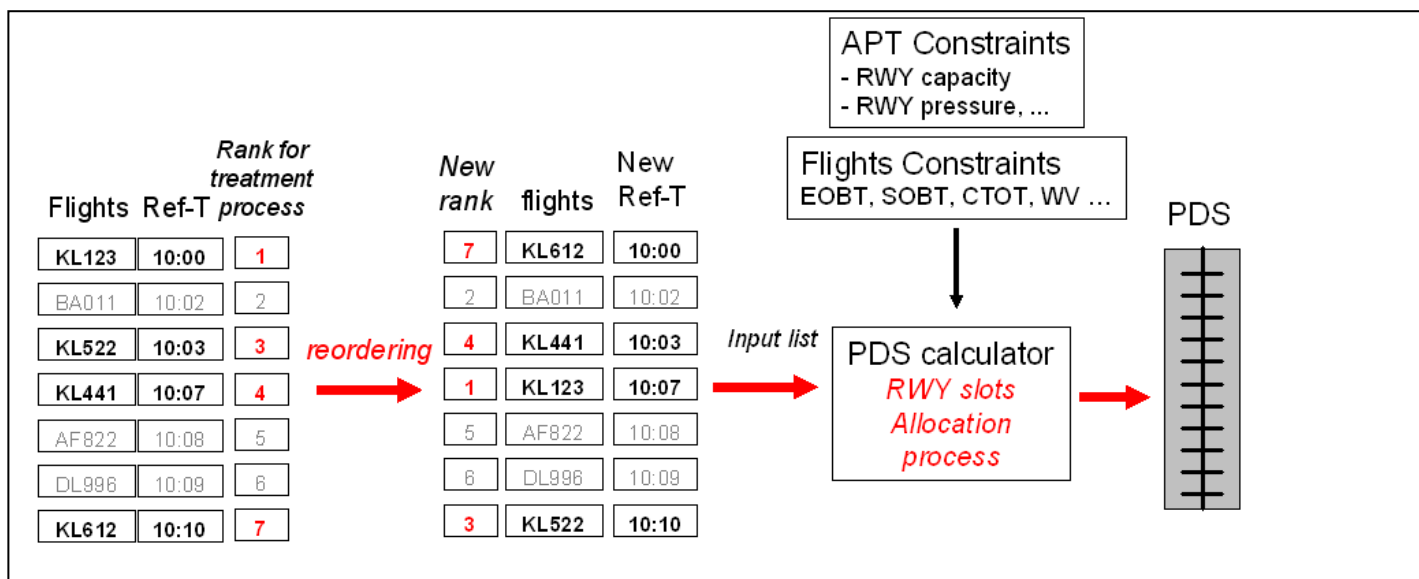

Figure 29: Principle of the Departure Reference-Time Reordering.

64. Procedure:

The AU will send a reordering request that may involve more than two flights. The objective is that the PDS system takes into account this new order in replacement of initial order for the TSAT calculation processing, to reflect AU prioritisation.

65. Optional features in addition to the nominal features:

None.

66. Required inputs and outputs:

As an input, AU provides the list of flights to reorder.
As an output, the new PDS calculation with allocated TSATs.

67. Triggering events:

An AU sends a reordering request.

68. Actors:

AU to select a sample of flights to be reordered.

69. Automatic actions:

The PDS system takes the request and processes a new TSAT calculation, in respect of issued CTOTs.

DPIs are sent to NM.

70. Sequence of services:

None.

71. Additional features:

None.

72. Requirements:

The CDM tool, which already displays the departure sequence, will offer the possibility to input the AUs' reordering requests.

The PDS algorithm needs to be updated to take into account, in its TSAT calculation, the modified flight order.

The reordering related data, including historic of requests will be available on the CDM tool.

3.2.3.2 First Priority for Departure

The objective is to give the opportunity for a flight, which has been allocated a delayed TSAT, to get a TSAT closer to its airline TOBT.

The AU needs to identify a flight as priority flight so that the PDS can allocate the best TSAT possible, above all the same AU other flights, as close as possible to the current time. Regulated flights cannot be improved in the departure sequence more than their Slot Tolerance Window permits.

The PDS upgrade function could allow processing this flight first (among all the same AU flights) by « down listing » the rest of the AU own flights.

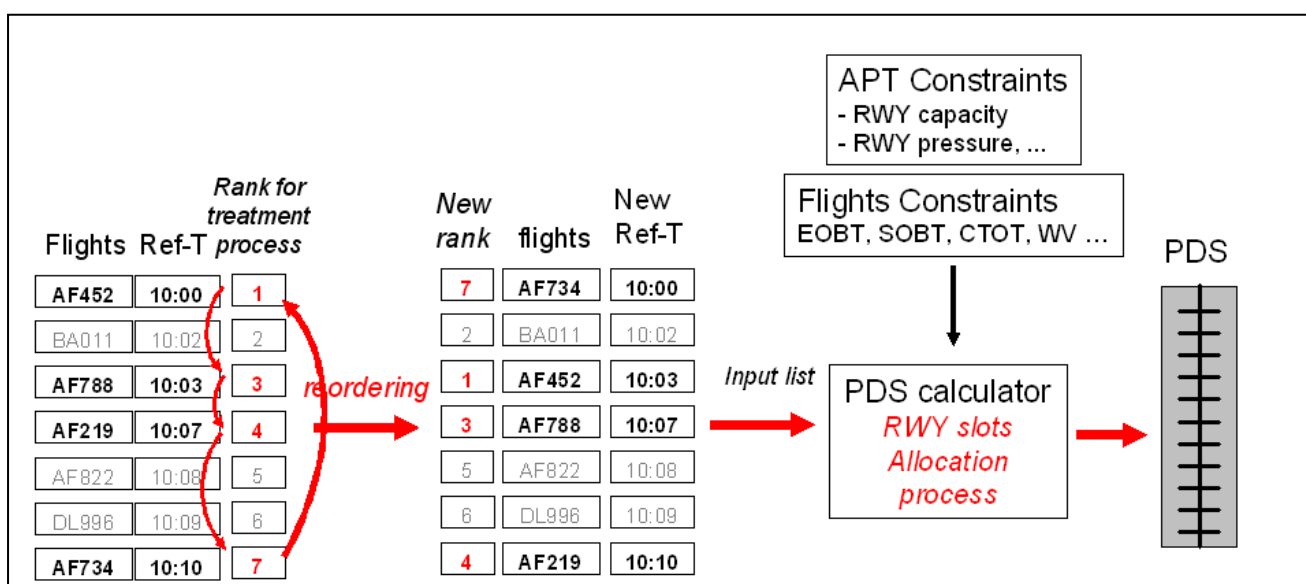

Figure 30: Principle of the First Priority for Departure.

73. Procedure:

The AU sends a First Priority for Departure request for a single flight. The PDS system reorders only this airline flight list before processing TSAT calculation. Only the flights operated by the same AU as the “requested” flight will be reordered: first rank given to this flight by moving down the AU own flights initially placed before. For equity concern, the order of PDS processing for the flights operated by other AUs is not modified.

74. Optional features in addition to the nominal features:

None.

75. Required inputs and outputs:

As an input, AU provides the identification of the prioritised flight.

As an output, the new PDS calculation with allocated TSATs.

76. Triggering events:

An AU sends a “First Priority for Departure” request.

77. Actors:

AU to select a specific flight to be prioritised.

78. Automatic actions:

The PDS system takes the request and processes a new TSAT calculation, in respect of issued CTOTs.

DPIs are sent to NM.

79. Sequence of services:

None.

80. Additional features:

None.

81. Requirements:

The CDM tool, which already displays the departure sequence, will offer the possibility to input the AUs’ “First Priority for Departure” prioritisation requests.

The PDS algorithm needs to be updated so that, for each flight prioritisation, it launches a cascading replacement process for all flights of the same AU in the PDS list.

The reordering related data, including historic of requests will be available on the CDM tool.

3.2.3.3 Upwards Cascade on Departure Cancellation

Develop the possibility for an AU of keeping the place in the APT departure sequence of a cancelled flight for its own other flights (ownership). The priority rank of a cancelled flight remains the airline property, and can be used for another flight of the same AU.

When the Upwards Cascade on Departure Cancellation process is triggered, all other flights of the same A.U. are improved automatically by the system, by substitution.

Constraint: Flights cannot be improved in the departure sequence more than their requested departure time. Regulated flights cannot be improved in the departure sequence more than their Slot Tolerance Window permits.

The substitution on cancellation allows an AU to benefit from its allocated RWY slot with a positive impact on the rest of his sequence of flights. It is very penalising for an AU to cancel a flight, and substitution on cancellation would at least counter-balance the loss, without impacting the rest of the traffic.

At the moment the AU cancels its flight, the system automatically reallocates the PDS processing priority rank to the following flights of the same AU, in a cascading way.

The cascade process stops at the end of the flights PDS list. (e.g: CDG processes flights in the PDS calculation 4h before SOBT; LHR PDS system processes flights 20 min before EOBT; MUC system processes 40 min in advance).

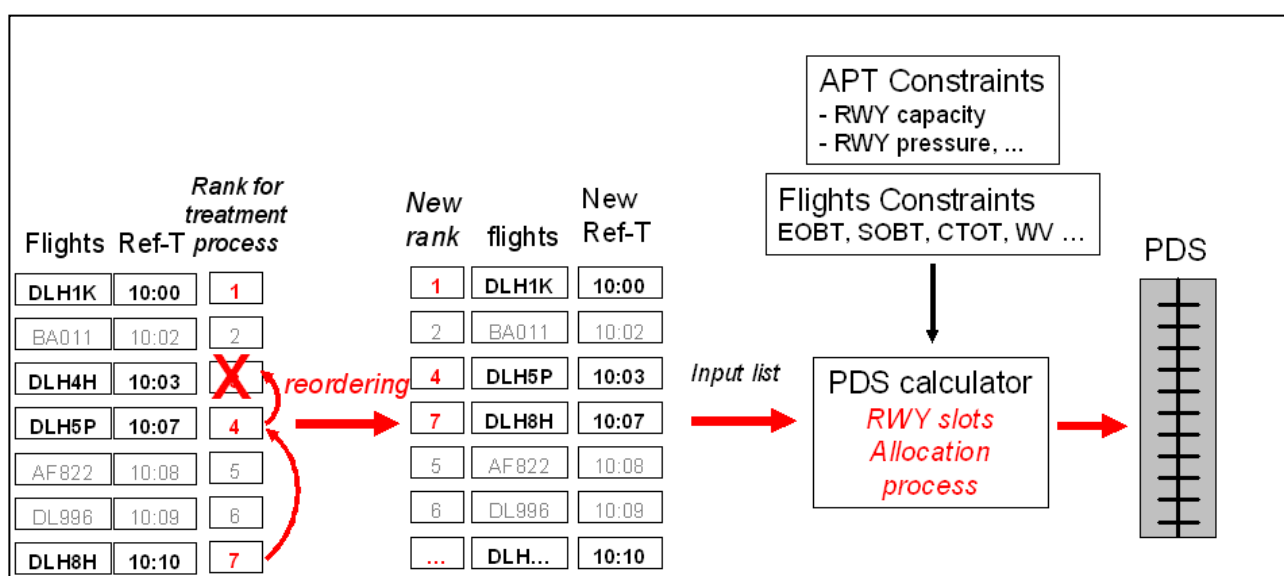

Figure 31: Upwards Cascade on Departure Cancellation.

82. Procedure:

No operational process change.

83. Optional features in addition to the nominal features:

None.

84. Required inputs and outputs:

Any flight cancellation should be treated as an input.

As an output, the new PDS calculation with allocated TSATs.

85. Triggering events:

An AU cancels a flight.

86. Actors:

AU to select a specific flight to be cancelled.

87. Automatic actions:

For each flight cancellation, the PDS system launches a cascading replacement process for all flights of the same AU in the PDS list.

DPIs are sent to NM.

88. Sequence of services:

None.

89. Additional features:

None.

90. Requirements:

The PDS algorithm needs to be updated so that, for each flight cancellation, it launches a cascading replacement process for all flights of the same AU in the PDS list.

3.2.3.4 UDPP Departure Summary Table

The main points of the UDPP Departure concept are summarized in the following table:

| | |
|---|---|
| Departure Reference-Time Reordering | A sample of flights can be reordered Process: based on priority of treatment Applicable to any CDM APT |
| First Priority for Departure | One single flight is processed first amongst AU's own flights Other flights from this AU are cascaded down |
| Upwards Cascade on Departure Cancellation | AU cancels a flight Other flights from this AU are cascaded up |

Table 6: UDPP Departure summary.

3.3 Differences between new and previous Operating Methods

3.3.1 UDPP Step1: a reactive but iterative process

UDPP Step 1 introduces more possibilities and flexibility for Airspace Users to exchange flights in a collaborative manner, at network level or at airport level.

The UDPP Step-1 is a reactive process, it can only be activated once a sequence is defined, and the information made available to AUs. It aims to provide Airspace Users more possibilities and flexibility in their operations once a sequence has been defined to enter a congested area. On En-route and Arrival congested areas, the sequence and associated delays is calculated by the Network Manager. On Departure CDM Airports, the sequence is defined by the CDM. The UDPP Step-1 will address those two configurations as follows:

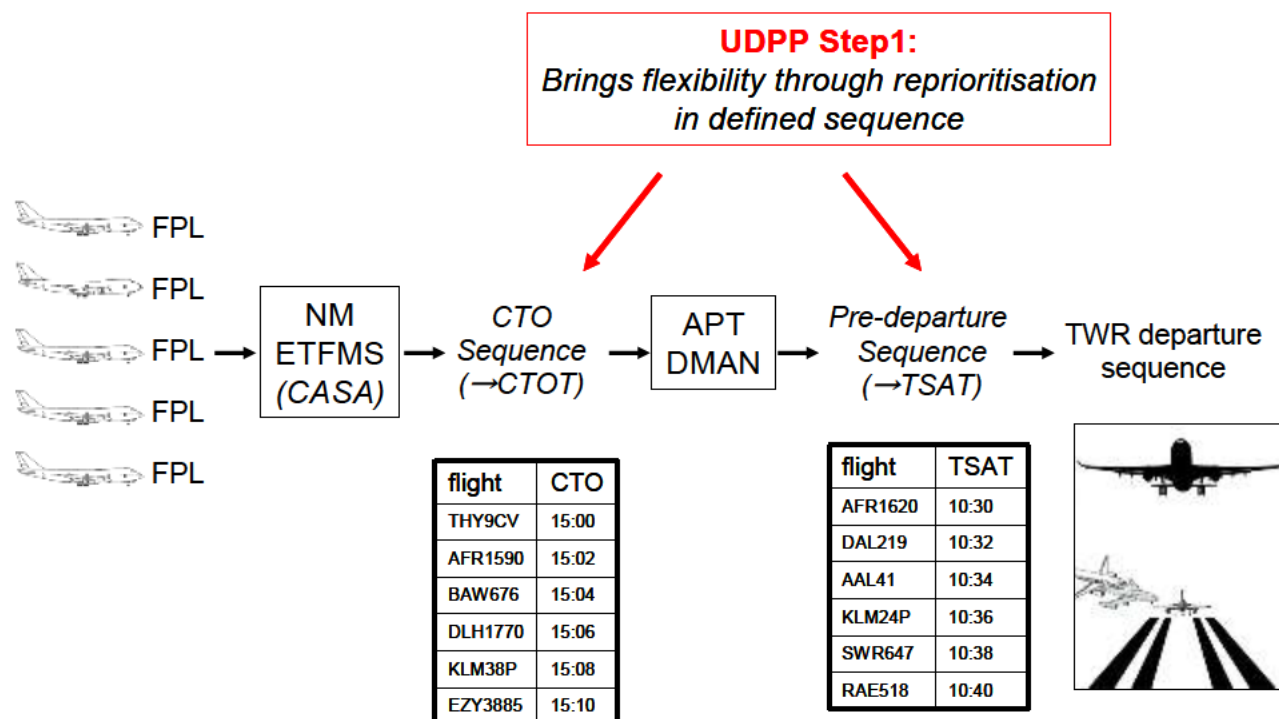

Figure 32: UDPP Step1 added flexibility.

3.3.2 Main Operational differences

3.3.2.1 ATFM Enhanced Slot Swapping:

3.3.2.2 What remains unchanged from the current ATFM Slot-Swapping

The UDPP AUO-0101-A Enhanced Slot-Swapping aims to provide Airspace Users increased Slot-swapping opportunities by extending the potential slot-swapping flights pairs. Once the Airspace User has identified the two flights to swap and triggered his request, the NM process to accept / reject the slot-swap remains unchanged.

The section 3.1.1.2.3 ATFCM Slot Swapping paragraph a) NM Slot Swapping procedure: details the current Slot-Swapping procedure, as defined by NM and described in the ATFCM Operations Manual - edition 16.0.

In the paragraphs below are highlighted the important points that remain unchanged.

1. The E-Helpdesk

“A request for a slot swap from an AO must be submitted via the E-Helpdesk. Whenever a request for a slot swap is received at the E-Helpdesk it should be handled by the receiving position.”

All Airspace Users Slot-swapping requests are processed by the NM operators via the NOP e-Helpdesk. Even if the Airspace Users would be provided a different and more user-friendly interface, this portal remains the NM interface to process the NOP acceptance/rejection.

2. Agreements between AUs

"NMOC shall not check whether flights are from the same operator or where there is a formal agreement between both aircraft operators for swaps to take place between their flights"

As stated in the section 2.2.1 Operational Concept Definition:: Although UDPP allows AUs to prioritise their own flights (within existing commercial agreements), AUs may negotiate between themselves, subject to final agreement of all actors. The process covers exchanges within and between Airspace Users and will leave room for Airspace Users to exchange and or swap slots if they individually agree to do so.

3. Slot-swaps triggered by FMPs

· "FMPs can request swaps for two flights of the same aircraft operator or, during critical events at airports, also for different aircraft operators;"

The possibility for an FMP to trigger a classic slot-swap for local capacity reasons will remain unchanged. This is not covered by the UDPP project, which is focused on "User Driven" processes.

4. Same Most Penalising Regulation

"The two flights must be subject to the same most penalizing regulation;"

This rule is of most importance to ensure equity and security. As a matter of fact, the Demand/Capacity imbalance may be different depending on the regulated Traffic Volume, resulting in different delays.

On a security point of view, swapping flights' delay at their Most Penalising Regulation ensures that the other regulations impacted those flights are less constrained, and consequently allow for some flexibility.

However this "same Most Penalising Regulation" concept should evolve to include A-CDM delay as explained in the Most Penalising Delay feature.

5. Impact on the Network assessment

"The swap should not be performed if the warning window (NID) shows an over delivery in the traffic volume counts."

When a slot-swap request is received at the NOP e-Helpdesk, the NM controller checks for potential safety issues. He uses the Network Impact Display (NID) to perform his analysis in order to make sure that no ATC volume will be overloaded as a result of the slot swap.

This process will remain unchanged with the introduction of the UDPP enhanced Slot-Swapping features.

(see explanation at paragraph e) Impact of a slot-swap on the Network: p 37

6. Slot-swapping principles and rules

As stated in section 2.2.5 UDPP principles earlier in this document, all Principles and Rules applying to ATFM Slot-swapping will remain as such for the Enhanced Slot-Swapping features.

However these principles and rules have been reworded to be less procedures & tools specifics

3.3.2.3 What changes from the current ATFM Slot-Swapping

The paragraphs below highlight the important points that get changed in the new Operating Methods, based on the description of ATFCM Slot Swapping section 3.1.1.2.3 paragraph a) NM Slot Swapping procedure:

1. Slot issued status

"The two concerned flights must be in status slot issued."

The new feature Pre-allocated slot-swap will allow a regulated flight to be swapped with a flight whose slot is still in the pre-allocated status.

2. Same Most Penalising Delay

"The two flights must be subject to the same most penalizing regulation;"

Although this rule will still be valid in case no higher delay is identified at the departure CDM Airport, it is subject to evolve with the Most Penalising Delay feature.

This feature will include A-CDM delay in the slot-swapping rules as if it was a delay generated by a classic regulation. Then two flights will be allowed to swap if they share the same Most Penalising Delay.

3. Multiple slot-swapping

"Only one swap per flight shall be accepted, except critical events (CHAMAN)"

This condition to be eligible for a slot swap will be extended to allow for multi slot-swap.

7. Impact of Slot-swap on CASA recalculation

"Where the swap may be performed, the improved flight should be left forced. The deteriorated flight should be unforced in order to:

- Better manage the traffic load, in case of a deep rectification (e.g deterioration of the acceptance rate);
- Allow further improvement of the CTOT, as a result of the true revision process."

TODAY: The CTO for the improved flight is frozen when a slot-swap is performed. **If there are many such frozen flights in the regulation and the capacity of the regulation is further reduced, the CASA algorithm may be unable to reduce the number of slots/flights to the new capacity. This 'failure mode' and its 'propagation effect' exist today.** However, the prototype swapping tool and the new swap features might increase the number of swap requests and therefore the number of frozen flights in a regulation.

NEW CONCEPT: The Time-Reference concept is bound to exchange Flights' Reference times in the 'Time Reference' Sequence, and then CASA will input this list and recalculate the new CTOs in the Regulation Slot Sequence.

As the new CTOs of the swapped flights will be the result of the re-calculation, slots will not have to be forced to maintain their new place in the sequence of the Most Penalizing Regulation traffic volume.

Slots being unforced, they will allow flexibility of slot re-allocation during the cyclic CASA recalculation process: no safety issue in case of a drastic reduction of capacity / no loss of slots in case of improvement of capacity.

4. Main Operational differences summary table

The main operational differences are summarized in the following table:

| | |
|--|---|
| Multi-swap of ATFM Slot Swap | A regulated flight can be swapped several times |
| Pre-allocated slot-swap | A slot-issued regulated flight can be swapped with a regulated flight with slot in pre-allocated status. |
| Most penalising delay | Most Penalising Constraint concept is extended to Most Penalising Delay: The A-CDM delay is taken into account in the slot-swapping rules as if it was a delay generated by a classic regulation. Then two flights will be allowed to swap if they share the same Most Penalising Delay. |
| ATFM Slot Substitution on Cancellation | AU cancels a regulated flight the ATFM slot remains “empty” until a time-out AU designates the replacing flight |

Table 7: Main enhanced Slot-swap operational differences.

3.3.2.4 UDPP Departure:

As the UDPP Departure features are not built from any existing device, all characteristics may be considered as new.

Slot-swapping principles and rules

As stated in section 2.2.5 UDPP principles earlier in this document, Principles and Rules applying to the current ATFM Slot-swapping have been reworded to be less procedure and tools specific, in order to be applicable to any UDPP Step-1 concept feature.

UDPP Departure differences Summary Table

The main operational differences are summarized in the following table:

| | |
|---|--|
| Departure Reference-Time Reordering | A sample of flights can be reordered Process: based on priority of treatment Applicable to any CDM APT |
| First Priority for Departure | One single flight is processed first amongst AU's own flights Other flights from this AU are cascaded down |
| Upwards Cascade on Departure Cancellation | AU cancels a flight Other flights from this AU are cascaded up |

Table 8: Main UDPP departure operational differences

3.3.3 The cheating issue

UDPP Step 1 introduces more possibilities and flexibility for Airspace Users to exchange flights in a collaborative manner, at network level or at airport level. While performing flight exchanges, each flight is considered on a case by case basis, and AU has responsibility for deciding which flight needs prioritisation through swapping. No debate and no judgment will be made on how an AU decides which flight needs to be exchanged.

This flight exchange will be performed according to a set of rules to be agreed between the participants in the process. The principles and rules that ensure fairness and equity are an extension of the current ATFM slot-swapping rules.

For exchanges within the same Aircraft Operator, the more flights going across the congested area, the more swapping possibilities. Although ATM rules strongly forbid cheating, some Aircraft Operators are tempted to fill in duplicated FPLs, creating ghost flights to allow for more slots choice.

To prevent from such practices, some solutions are being worked out by specific Task-Forces:

- The next FPL version planned to be on operations in 2018 will include the airport slot, allowing for cross check.
- The GUFID (Global Unique Flight Identifier), as described in the ICAO 12th Air Navigation Conference report (30 Nov 2012): this proposed item specifies a globally unique reference for a flight, allowing all eligible members of the ATM Community to unambiguously pertain to that flight. The GUFID would be used in any further sharing of information concerning the flights.

Although ATFM slot-swapping already exists, even with the actual risk of ghost flights filled in for getting slots opportunities, the UDPP step 1 is aware of the issue and monitors closely the progress on anti-cheating solutions.

3.3.4 Impact of UDPP on HOTSPOTS

This chapter investigates the interactions between UDPP and STAM.

3.3.4.1 HOTSPOTS and 'informal STAM' in current operations:

Although STAM measures are not officially deployed in Current operations, some ANSPs have a demand/capacity balancing process very close to STAM. However, this 'Informal-STAM' practices are informal and not transparent to NM.

The ANSPs that practice 'Informal-STAM' are MUAC, DSN (REIMS), and NATS. These monitor their traffic demand/capacity balance very precisely, using Occupancy Counts.

Swapping should not impact STAM for two reasons. First, when STAM is created (but not earlier i.e. in draft or coordination), ETM creates proposal flights to book the modified flights. NMOC and others can see the proposals and detect with the flight list or in the details of a flight that a flight has a proposal, so the airspace users should not be proposing swap solutions with such flights. Second, STAM does not touch flights that are in regulations, whereas ATFM swapping can only occur between flights that are regulated.

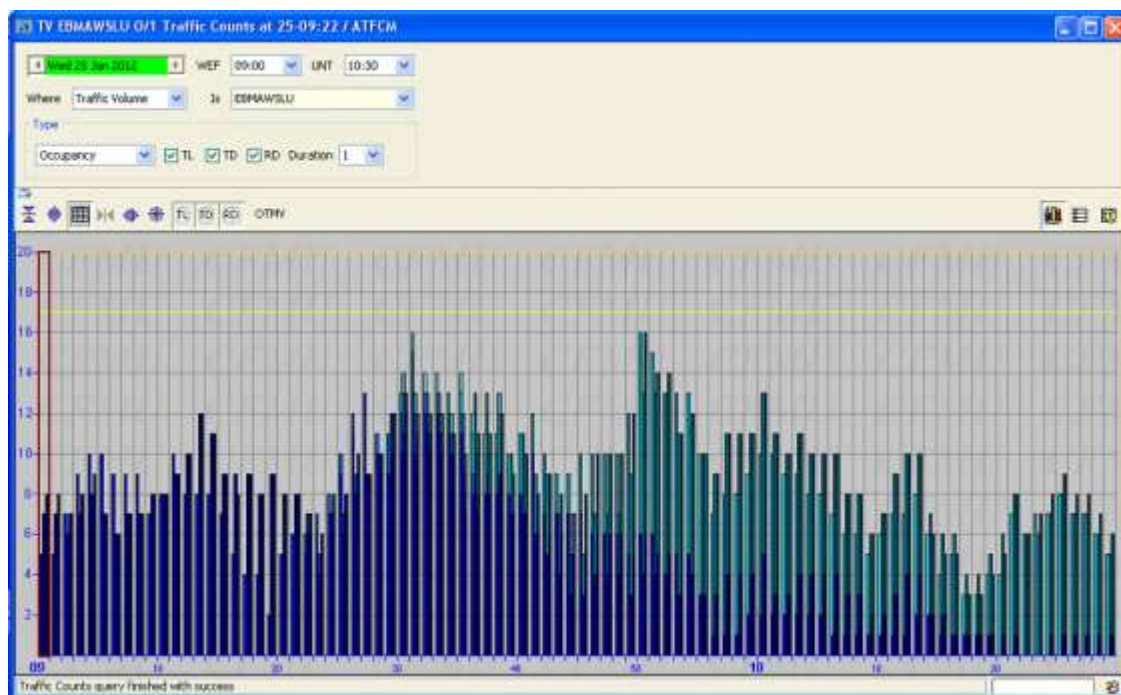

Figure 33: Display of Occupancy Counts.

Each column represents the number of flights that will be present in the sector over a certain period of time.

MUAC uses a pace of 1 minute to monitor the occupancy counts, RIEMS uses an average over 11 minutes, and NATS uses an average over a period of 15 min.

In case of the 'Occupancy Count' exceeding the capacity rate of the ATC Traffic Volume, the ANSP will take specific measures to prevent from any safety issue.

Instead of publishing a Regulation to solve their demand/capacity imbalance, these ATC Centres analyse the traffic on a case-by-case basis, and spot the flights that could be managed to solve the over-capacity issue. They pull the designated flights out of the Traffic Volume by coordinating in advance with adjacent ATC centres and getting agreement on a specific ATC measure such as a Level-Cap, a re-route, etc.

However there is no formal procedure to inform NM that a change in a Flight's trajectory was triggered to solve a safety issue linked to a demand/capacity imbalance in a Hotspot.

3.3.4.2 Impact of UDPP on HOTSPOTS in current operations:

When receiving a Slot-swap request, the NMOC operator uses the NID (Network Impact Display) to assess if the slot-swap would create an overload in a Traffic volume.

However, the NID doesn't take into account the Hotspots. In consequence, even if the NID shows that the slot-swap is safe with regards to published regulations, the NMOC operator doesn't have any mean to assess if swapping the flight will create or not a safety issue in a Hotspot.

Today this hazard already exists with current slot-swapping. The process to assess the Impact of a slot-swap on the Network does not take into account the STAM activities. There is no reconciliation process between STAM flight (ATC) and APT (pre-sequence)

3.3.4.3 UDPP / STAM reconciliation:

By formalising the Hotspots and STAM measures in the future, the STAM project will allow NMOC to be aware of Hotspots and prevent any safety issue of slot-swapping impacting Hotspots' Demand Capacity Balance.

Process and rules need to be defined to integrate Slot-swapping and STAM into the SESAR environment.

Several uses case have been investigated:

Case 1:

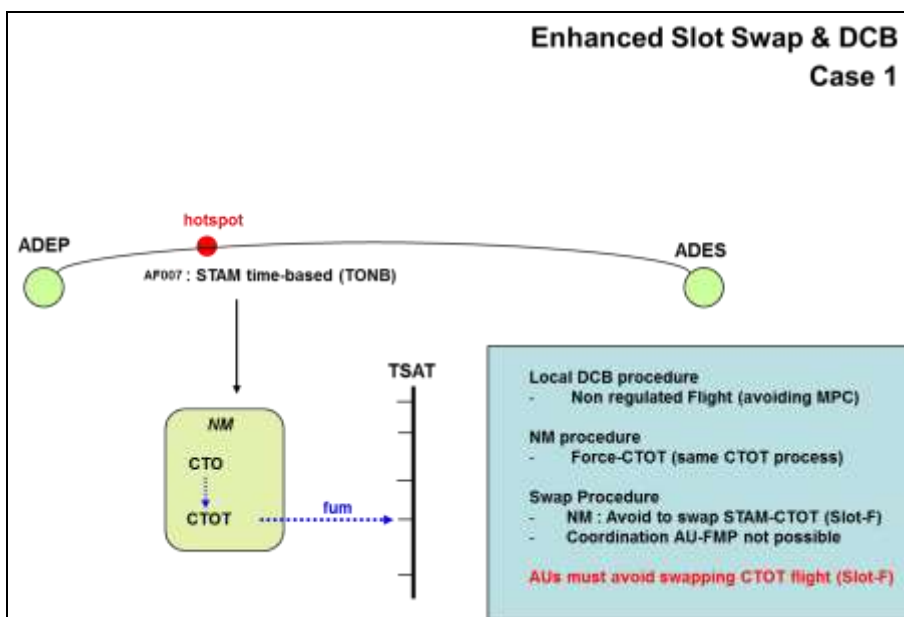
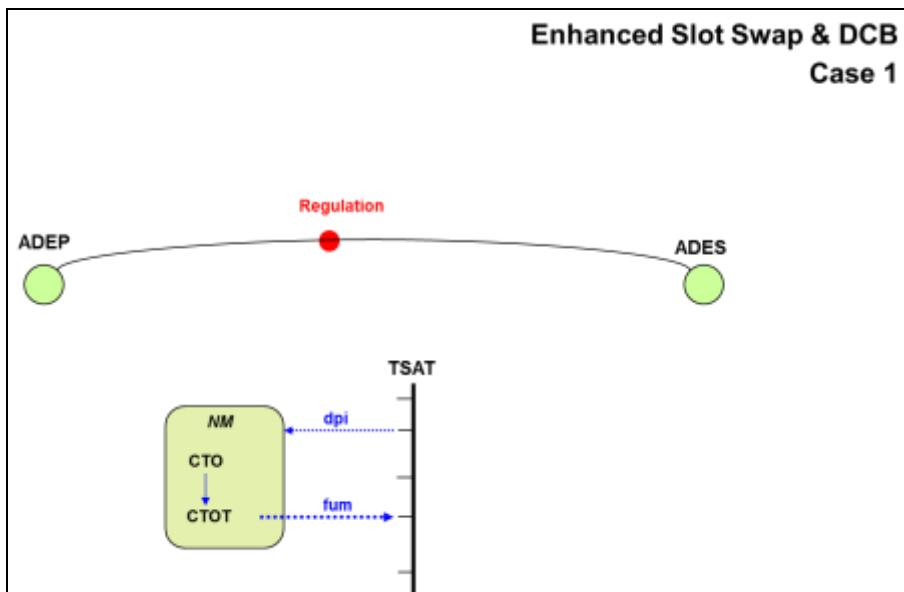

Case 2:

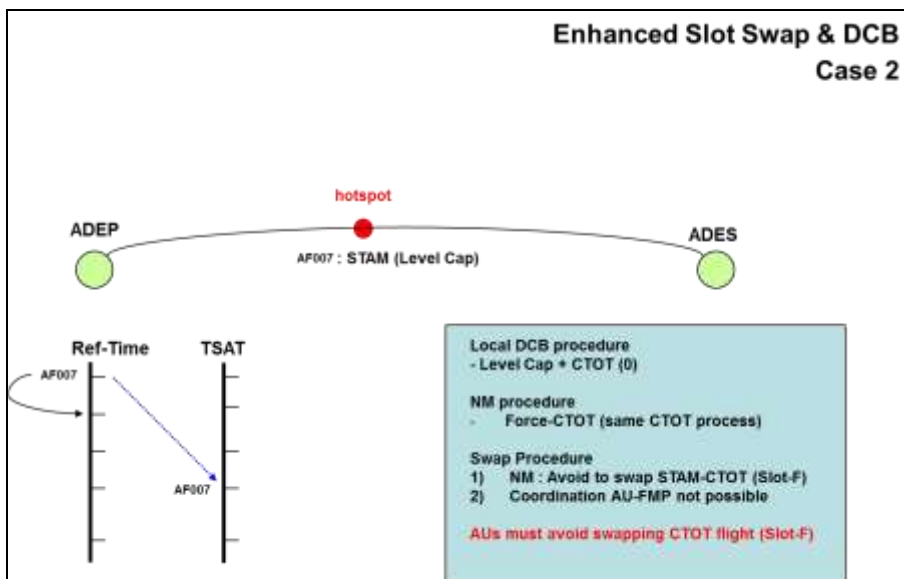
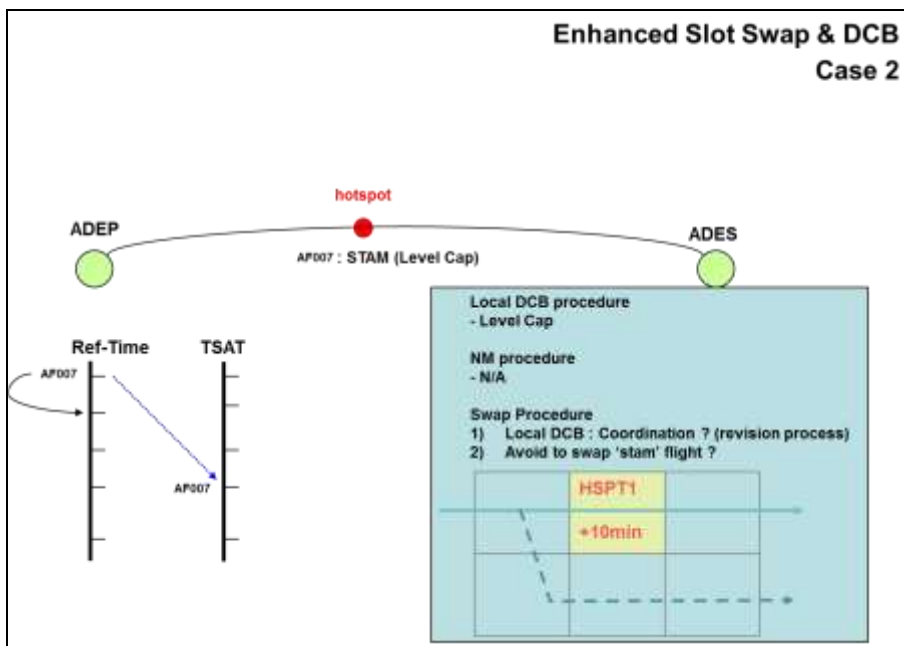

Case 3:

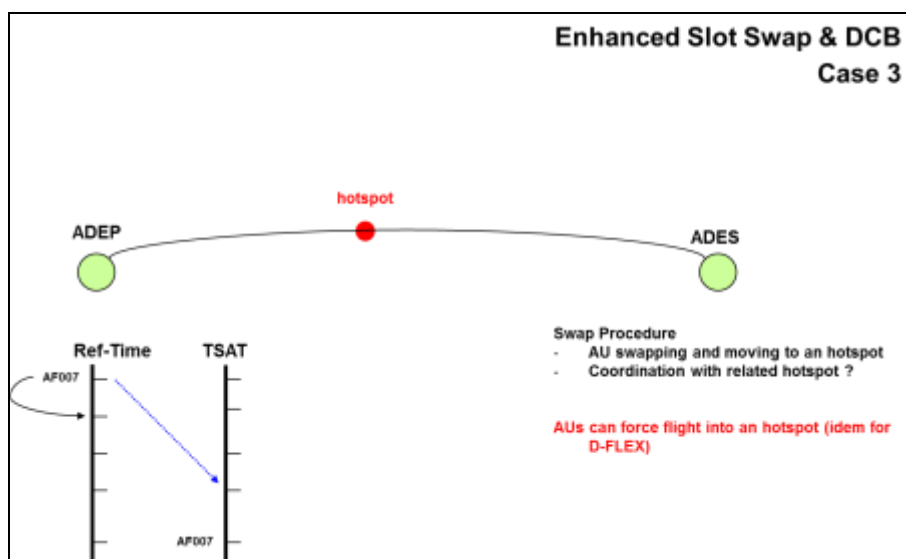

Case 4:

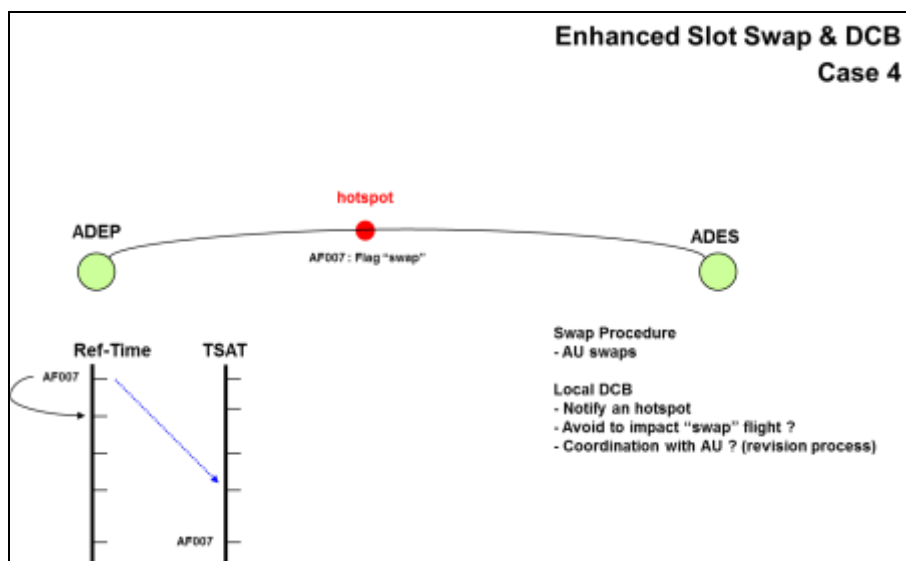

The Solution

- ❖ Provide hotspot and STAM information to the AUs
- ❖ Define clear rules
 - ❖ *Flight cannot be STAM if swap*
 - ❖ *Flight cannot be swap if STAM*
 - ❖ *Flight cannot be swap if entering into an hotspot ?*
 - ❖ Define a revision process to re-assess the planned measure
 - ❖ Coordination
 - ❖ What-if (integrated Airport & En-Route impact assessment)
 - ❖ Hotspot, DCB constraints

4 Detailed Operational Environment

4.1 Operational Characteristics

This section is described in DOD 07.02 [5].

4.2 Roles and Responsibilities

This section is described in DOD 07.02 [5].

4.3 Constraints

The existing infrastructure for sharing information on flight exchanges between AU and ATC / NM / CDM APT shall be used. No additional constraints are foreseen.

5 Use Cases

5.1 Operational Scenario 1 - En-route Demand/Capacity imbalance under degraded situation

June, an en-route ATC controllers strike over Reims ACC reduces capacity. Although Airspace Users cancelled a number of their flights, a severe Demand / Capacity imbalance impacts En-route sector. NM publishes a regulation, thus all flights entering the regulated sector are allocated a CTOT.

To reach their strategy, Airspace Users make use of the enhanced Slot-Swapping (eSS) capabilities, so that their most important flights can be prioritised.

5.1.1 USE CASE 1 - ATFM Slot Substitution on Cancellation

Summary:

- 1- Due to high delay, AFR 1620 is about to be cancelled by the FOC. The flight dispatcher searches in the UDPP Slot-Swapping Tool which other flight would be of highest value to take the slot. He decides to trigger the ATFM Slot Substitution on Cancellation to find the best strategic option.
- 2- Using the USST, AFR FOC investigates which flights are possibly able to catch the released ATFM slot.
Constraint: the replacing flight should have the same Most Penalising Regulation.
2 flights are found possible for substitution: AFR547 and RAE264.
AFR FOC analyses what would be the highest benefit, either cost benefit, connecting passengers, or airport slot adherence, etc.
- 3- Decision is taken to designate RAE264 for substitution. AFR FOC acts accordingly and provides information to NM and APT.

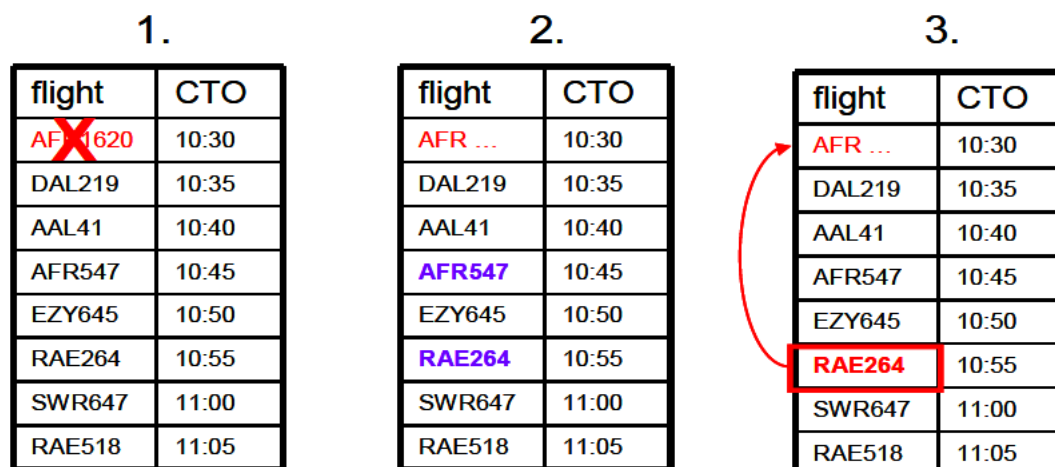

Figure 34: Use case 1: ATFM Slot Substitution on Cancellation.

5.1.1.1 Use case 1.1 – Identify the need and initiate the UDPP process

Summary:

This Use Case is triggered when the AU experiences a need for a flight cancellation on day of operations.

E.g.:

A severe Demand / Capacity imbalance impacts traffic. AU decides to cancel one regulated flight, and initiates the “ATFM Slot Substitution on Cancellation” process.

5.1.1.1.1 Preconditions:

PreC1.1.1 – Flight candidate for cancellation has an ATFM slot, in the status “issued slot”.

PreC1.1.2 – Time for cancellation action should not be later than xxx min prior to CTOT.

5.1.1.1.2 Actors:

Ac1 - Airspace User

He is responsible for the monitoring of his flights operations, the assessment of the level of deterioration, and triggering the UDPP process for ATFM Slot Substitution on Cancellation.

Ac2 - Network Manager

NM has no role in the identification of flight cancellation and initiation of the “ATFM Slot Substitution on Cancellation” process.

Ac3 - ATC

ATC has no role in the identification of flight cancellation and initiation of the “ATFM Slot Substitution on Cancellation” process.

5.1.1.1.3 Operating method:

Table below provides the high level description of the new operating method for the “ATFM Slot Substitution on Cancellation” process, in the form of successive steps to be implemented as it progresses into the system.

5.1.1.1.3.1 Main Flow:

| Step | Actor | Action | Tool |
|---------|-------|---|-----------------|
| UC1.1.1 | A.U. | Identifies Flight “A” as candidate for a “ATFM slot Substitution on Cancellation” process. See pre-conditions here-above for candidate flight. | CHMI / NOP |
| UC1.1.2 | A.U. | Processes the request to NM. The request must be submitted with all necessary information for NM to treat it. | (NOP helpdesk?) |
| UC1.1.3 | A.U. | Is notified that the request has been submitted successfully. | (NOP helpdesk?) |
| UC1.1.4 | | | |
| UC1.1.5 | | | |
| UC1.1.6 | | | |
| UC1.1.7 | | | |
| UC1.1.8 | | | |
| UC1.1.9 | | | |

5.1.1.1.3.2 Alternative Flows:

No alternative flow was identified.

5.1.1.1.4 Post-conditions:

5.1.1.1.4.1 Success End State:

PostC1.1.1 – A.U. is notified that request has been successfully transmitted.
PostC1.1.2 -

5.1.1.1.4.2 Failure End State:

PostC1.1.3 - Delivery of notification message to AU, indicating request has failed
PostC1.1.4 -
PostC1.1.5 -

5.1.1.2 Use case 1.2 – Develop UDPP measures

Summary:

This Use Case is the continuity of the previous one. It is triggered when Use Case 1.1 has been successfully conducted.

5.1.1.2.1 Preconditions:

PreC1.2.1 – success of previous part 5.1.1
PreC1.2.2 – replacing flight should have same MPR as cancelled one
PreC1.2.3 – replacing flight should be indicated xxx min before departure, in line with current NM procedures

5.1.1.2.2 Actors:

Main actors:

AU and NM have a major role in the development and implementation of the “ATFM Slot Substitution on Cancellation” process. They develop the adequate measures as described in the operating method below.

Secondary actors:

APT, ANSPs, and FMPs are informed of the issue of the use-case, if they are impacted.

5.1.1.2.3 Operating method:

Table below provides the high level description of the new operating method for the ATFM Slot Substitution on Cancellation process, in the form of successive steps to be implemented as it progresses into the system.

5.1.1.2.3.1 Main Flow:

| Step | Actor | Action | Tool |
|---------|-------|--|-------|
| UC1.2.1 | N.M. | NM assess the Impact on the Network of the candidate flight only | EFTMS |
| UC1.2.2 | N.M. | NMOC takes decision whether to accept or reject the request | ETFMS |
| UC1.2.3 | N.M. | AU receives confirmation of acceptance of request. In case of rejection, use case-end | |
| UC1.2.4 | A.U. | CNL message to IFPS | IFPS |
| UC1.2.5 | | | |
| UC1.2.6 | | | |
| UC1.2.7 | | | |
| UC1.2.8 | | | |
| UC1.2.9 | | | |

5.1.1.2.3.2 Alternative Flows:

Automation of main flow

| Step | Actor | Action | Tool |
|---------|-------|---|------|
| UC1.1.1 | A.U. | CNL message to IFPS (A special format of Cancellation may exist) | IFPS |
| UC1.1.2 | | | |
| UC1.1.3 | | | |
| UC1.1.4 | | | |
| UC1.1.5 | | | |
| UC1.1.6 | | | |
| UC1.1.7 | | | |
| UC1.1.8 | | | |
| UC1.1.9 | | | |

5.1.1.2.4 Post-conditions:

5.1.1.2.4.1 Success End State:

PostC1.2.1 - Delivery of a notification message to AU, indicating success that the slot is substituted.
PostC1.2.2 - Delivery of a CNL message to ATC

5.1.1.2.4.2 Failure End State:

PostC1.2.3 - Delivery of notification message to AU, indicating rejection and reason.

5.1.1.3 Use case 1.3 – Collaboratively agree and implement UDPP measure

Summary:

This Use Case is the continuity of the previous one. It is triggered when Use Case 1.2 has been successfully conducted.

5.1.1.3.1 Preconditions:

PreC1.3.1 – success of previous part 5.1.2

PreC1.3.2 – replacing flight should have same MPR as cancelled one

PreC1.3.3 – replacing flight should be indicated within the time-out period

PreC1.3.4 – replacing flight should be indicated xxx min before departure, in line with current NM procedures

5.1.1.3.2 Actors:

Main actors:

AU and NM implement the adequate measures as described in the operating method below.

Secondary actors:

None identified.

5.1.1.3.3 Operating method:

Table below provides the high level description of the new operating method for the implementation of ATFM Slot Substitution on Cancellation process, in the form of successive steps to be implemented as it progresses into the system.

5.1.1.3.3.1 Main Flow:

| Step | Actor | Action | Tool |
|---------|-------|--|------|
| UC1.3.1 | NM | The candidate flight is allocated the slot of the subject flight to be cancelled | (|
| UC1.3.2 | NM | The subject flight is cancelled | |
| UC1.3.3 | NM | A SRM is sent to AU | |
| UC1.3.4 | AU | If request is rejected, AU receives notification | |
| UC1.3.5 | | | |
| UC1.3.6 | | | |
| UC1.3.7 | | | |
| UC1.3.8 | | | |
| UC1.3.9 | | | |

5.1.1.3.3.2 Alternative Flows:

No alternative flow was identified.

5.1.1.3.4 Post-conditions:

5.1.1.3.4.1 Success End State:

PostC1.3.1 - Delivery of a notification message to AU, indicating Network system response to request: validation= SRM / rejection.

PostC1.3.2 - Delivery of a notification message to ATC (SRM).

5.1.1.3.4.2 Failure End State:

PostC1.3.3 - Delivery of notification message to AU, indicating rejection.

5.1.2 USE CASE 2 - Multi-swap of ATFM Slot Swap

Summary:

- 1- AFR FOC triggers a slot swap between AFR1620 and AFR547, sharing the same Most Penalising Regulation, as done in current operational procedure.
- 2- A few min later, AFR1620 gets a maintenance problem at the departure airport, and will not be able to be compliant with its allocated CTOT. AFR FOC decides to trigger another slot swap via the current procedure between AFR1620 and RAE264, as they share the same Most Penalising Regulation.

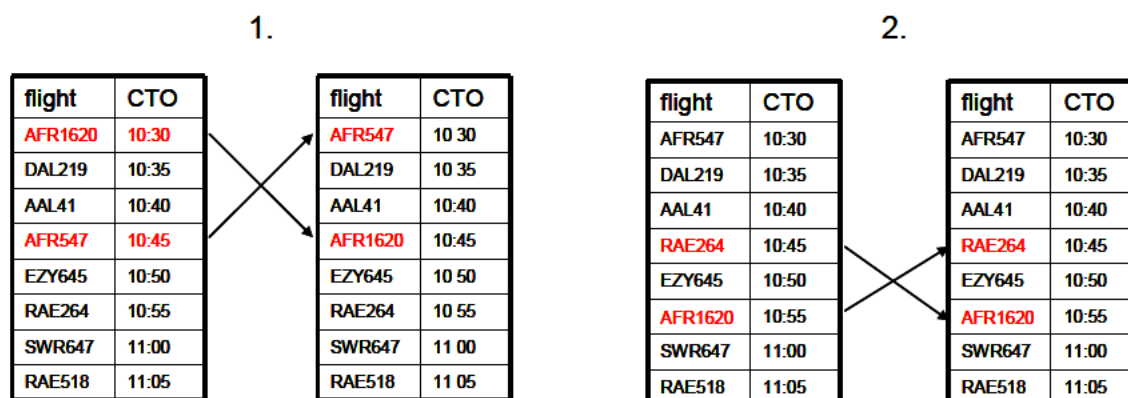

Figure 35: Use Case 2: Multi-swap of ATFM Slot Swap.

5.1.2.1 Use case 2.1 – Identify the need and initiate the UDPP process

Summary:

This Use Case is triggered when the AU experiences a need for a multi ATFM slot swap on day of operations. The multi-slot swap is a repetition of the current slot-swap already in operations.

E.g.:

AU has already performed a slot swap between 2 aircraft “A” and “B”; it identifies the need to process another slot-swap between “A” and “C”, the “A” aircraft having been already involved in the first slot-swap.

5.1.2.1.1 Preconditions:

PreC2.1.1 – An initial slot-swap has already been validated and processed between A and B. A has been delayed, B has been improved. B is now in “forced status” and cannot be swapped again. Only “A” may be candidate for a multi-slot swap.

PreC2.1.2 – Flight “A” is in Slot-issued status.

PreC2.1.3 – Flight “A” has already been swapped previously, but is not in Forced Slot Status.

PreC2.1.4 – Flight “C” is in Slot-issued status.

PreC2.1.5 – Flight “C” is not in Forced Slot Status

PreC2.1.6 – Flights “A” and “C” must share the same Most Penalising Regulation.

5.1.2.1.2 Actors:

Ac1 - Airspace User

He is responsible for the monitoring of his flights operations, the assessment of the level of deterioration, and triggering the UDPP process for the “Multi ATFM slot swap” process.

Ac2 - Network Manager

NM has no role in the identification and initiation of the “Multi ATFM slot swap” process.

Ac3 - ATC

ATC has no role in the identification and initiation of the “Multi ATFM slot swap” process.

5.1.2.1.3 Operating method:

Table below provides the high level description of the new operating method for the “Multi ATFM slot swap” process, in the form of successive steps to be implemented as it progresses into the system.

5.1.2.1.3.1 Main Flow:

| Step | Actor | Action | Tool |
|---------|-------|---|-----------------|
| UC2.1.1 | A.U. | Identifies Flight “A” and Flight “B” as candidates for an ATFM slot swap. See pre-conditions here-above for candidate flights. | CHMI / NOP |
| UC2.1.2 | A.U. | Processes the request in the NOP helpdesk, following the current NM procedure for slot-swap request. The request must be submitted with all necessary information for NM to treat it. | NOP helpdesk |
| UC2.1.3 | A.U. | Is notified that the request has been submitted successfully. | (NOP helpdesk?) |
| UC2.1.4 | | | |
| UC2.1.5 | | | |
| UC2.1.6 | | | |
| UC2.1.7 | | | |
| UC2.1.8 | | | |
| UC2.1.9 | | | |

Note: tools are indicated here just as suggestions to illustrate a level of feasibility. The system team will study the requirements and define the best solution.

5.1.2.1.4 Alternative Flows:

No alternative flows were identified.

5.1.2.1.5 Post-conditions:

5.1.2.1.5.1 Success End State:

PostC2.1.1 – A.U. is notified that request has been successfully transmitted.

PostC2.1.2 -

5.1.2.1.5.2 Failure End State:

PostC2.1.3 - Delivery of notification message to AU, indicating request has failed

PostC2.1.4 -

PostC2.1.5 -

5.1.2.2 Use case 2.2 – Develop UDPP measures

Summary:

This Use Case is the continuity of the previous one. It is triggered when Use Case 2.1 has been successfully conducted.

5.1.2.2.1 Preconditions:

- PreC2.2.1 – success of previous part 5.2.1
- PreC2.2.2 – AU slot-swap request has been received by N.M.
- PreC2.2.3 – candidate flights for swap should have the same MPR

5.1.2.2.2 Actors:

Main actors:

AU and NM have a major role in the development and implementation of the “Multi ATFM slot Swap” process. They develop the adequate measures as described in the operating method below.

Secondary actors:

APT, ANSPs, and FMPs are informed of the issue of the use-case, if they are impacted.

5.1.2.2.3 Operating method:

Table below provides the high level description of the new operating method for the development of the “Multi ATFM slot Swap” process, in the form of successive steps to be implemented as it progresses into the system.

5.1.2.2.3.1 Main Flow:

| Step | Actor | Action | Tool |
|---------|-------|---|--------------|
| UC2.2.1 | N.M. | Request is taken over. | NOP helpdesk |
| UC2.2.2 | N.M. | Impact of the slot-swap on the network is assessed. | ETFMS NID |
| UC2.2.3 | N.M. | If the impact on the network is satisfying, slot-swap is accepted. If not demand is rejected. | ETFMS NID |
| UC2.2.4 | N.M. | Acceptance/ reject is made available to A.U. | NOP helpdesk |
| UC2.2.5 | | | |
| UC2.2.6 | | | |
| UC2.2.7 | | | |
| UC2.2.8 | | | |
| UC2.2.9 | | | |

5.1.2.2.3.2 Alternative Flows:

No alternative flows were identified.

5.1.2.2.4 Post-conditions:

5.1.2.2.4.1 Success End State:

- PostC2.2.1 – A.U. is notified of validation of the request
- PostC2.2.2 -
- PostC2.2.3 -

5.1.2.2.4.2 Failure End State:

PostC2.2.3 - A.U. is notified of rejection of the request with reason (e.g. time is too close to departure and the request cannot be processed; flight is no longer regulated: regulation was cancelled during processing).

5.1.2.3 Use case 2.3 – Collaboratively agree and implement UDPP measure

Summary:

This Use Case is the continuity of the previous one. It is triggered when Use Case 2.2 has been successfully conducted.

5.1.2.3.1 Preconditions:

PreC2.3.1 – success of previous part 5.2.2

PreC2.3.2 –

5.1.2.3.2 Actors:

Main actors:

AU and NM have a major role in the development and implementation of the “Multi ATFM slot Swap” process. They develop the adequate measures as described in the operating method below.

Secondary actors:

APT, ANSPs, and FMPs are informed of the issue of the use-case, if they are impacted.

5.1.2.3.3 Operating method:

Table below provides the high level description of the new operating method for the “Multi ATFM slot Swap” process, in the form of successive steps to be implemented as it progresses into the system.

5.1.2.3.3.1 Main Flow:

| Step | Actor | Action | Tool |
|---------|-------|--|---------------|
| UC2.3.1 | N.M. | The N.M. system processes the slot-swap between the 2 CTOs. Flight “C” is forced to its new CTO. Flight “A” gets the old Flight “C” CTO. | ETFMS |
| UC2.3.2 | N.M. | New CTOT is allocated to Flight “C”. Flight “C” is in “Forced Slot” status. | ETFMS |
| UC2.3.3 | N.M. | New CTOT is allocated to Flight “A”. Flight “A” remains into issued slot status. | ETFMS |
| UC2.3.4 | N.M. | Flights “A” and “B” CTOTs are updated into the ETFMS Flight List. | ETFMS |
| UC2.3.5 | N.M. | A Slot Revision Message for Flights “A” and “C” with new CTOT is sent to AU, APT, ANSPs, and FMPs. | ETFMS |
| UC2.3.6 | A.U. | Receives the Slot Revision Message for Flights “A” and “C”. | AU own system |
| UC2.3.7 | A.U. | Takes necessary action with regards to operations, according to current procedure for a slot-swap (informs crew, station platform for handling services, etc.) | AU own system |
| UC2.3.8 | | | |
| UC2.3.9 | | | |

5.1.2.3.3.2 Alternative Flows:

No alternative flows were identified.

5.1.2.3.4 Post-conditions:

5.1.2.3.4.1 Success End State:

PostC2.3.1 - Delivery of a notification message to AU, indicating end of process.

PostC2.3.2 - Delivery of a notification message to ATC, indicating FPL change.

PostC2.3.3 - Delivery of a notification message to NM, indicating end of process.

PostC2.3.4 -

PostC2.3.5 -

5.1.2.3.5 Failure End State:

PostC2.2.6 - Delivery of a notification message to AU and NM, indicating failure of system processing.

PostC2.2.7 -

PostC2.2.8 - with reason (e.g. time is too close to CTOT to process the request; flight is no longer regulated: regulation was cancelled during processing).

5.1.3 USE CASE 3 – Pre-allocated Slot Swap

Summary:

- It is 10:00 UTC on day of operations.
- BAW464 is departing from Cyprus Larnaca (LCA) with EOBT 10:00, ETOT 10:20, landing in London with an ETA 15:30.
This flight is subject to a regulation 35min before landing in London, with a CTO (Calculated Time Over) 15:35. Its ATFM slot (CTOT 11:00) has been issued at 09:00. BAW464 is in “Slot-issued” state.
- BAW389 is scheduled to depart from Brussels with EOBT 13:25, ETOT 13:45, landing in London with an ETA 14:55. It is affected by the same Most Penalising Regulation, but slot is still in pre-allocated status. Its ATFM slot will only be issued at 11:25.
- On the flight list available on CHMI or NOP, British Airways FOC can observe that both BAW389 and BAW464 share the same Most Penalising Regulation, with their associated CTOT, whether in slot-allocated status or in pre-allocated status.
- BAW389 has a CTO (Calculated Time Over) 15:00 into the regulation, whereas BAW464’s CTO (Calculated Time Over) is 15:35. From the Aircraft Operator’s point of view, BAW464 is more important. He wants to prioritise it by swapping slot with BAW389. If he does, BAW 464’s new CTOT will be 5 min later than filled ETOT, then BAW 464 will arrive almost in time, only 5 min later than initial ETA.
- However, as it is 10:00 UTC, BAW389 is still in pre-allocated slot status. If only issued slots can be swapped, this means the FOC has to wait until 11:25 to request the slot-swap. This is after BAW 464 has taken-off. No slot swap will be possible.
- With the pre-allocated slot-swap, the FOC may request the slot-swap in time to be acted.



Figure 36: Use Case 3: Pre-allocated ATFM slot-swap.

5.1.3.1 Use case 3.1 – Identify the need and initiate the UDPP process

Summary:

This Use Case is triggered when the AU experiences a need for a Pre-allocated Slot Swap on day of operations.

E.g.: AU identifies the need within its operations for Flight “A” to land earlier, by getting the Flight “B”’s slot. It initiates a Pre-allocated ATFM slot-swap between Flight “A” and Flight “B”.

5.1.3.1.1 Preconditions:

PreC3.1.1 – Flight “A” is in Slot-issued status.

PreC3.1.2 – Flight “A” is not in Forced Slot Status

PreC3.1.2 – Flight “B” is in Pre-allocated ATFM slot status.

PreC3.1.2 – Flights “A” and “B” must share the same Most Penalising Regulation.

5.1.3.1.2 Actors:

Ac1 - Airspace User

He is responsible for the monitoring of his flights operations, the assessment of the level of deterioration, and triggering the UDPP process for the “Pre-allocated ATFM slot swap”.

Ac2 - Network Manager

NM has no role in the identification and initiation of the “Pre-allocated ATFM slot swap” process.

Ac3 - ATC

ATC has no role in the identification and initiation of the “Pre-allocated ATFM slot swap” process.

5.1.3.1.3 Operating method:

Table below provides the high level description of the new operating method for the “Pre-allocated ATFM slot swap” process, in the form of successive steps to be implemented as it progresses into the system.

5.1.3.1.3.1 Main Flow:

| Step | Actor | Action | Tool |
|---------|-------|--|-----------------|
| UC3.1.1 | A.U. | Identifies Flight “A” and Flight “B” as candidates for a “Pre-allocated ATFM slot swap”. See pre-conditions here-above for candidate flights. | CHMI / NOP |
| UC3.1.2 | A.U. | Processes the request to NM. The request must be submitted with all necessary information for NM to treat it. | (NOP helpdesk?) |
| UC3.1.3 | A.U. | Is notified that the request has been submitted successfully. | (NOP helpdesk?) |
| UC3.1.4 | | | |
| UC3.1.5 | | | |
| UC3.1.6 | | | |
| UC3.1.7 | | | |
| UC3.1.8 | | | |
| UC3.1.9 | | | |

5.1.3.1.3.2 Alternative Flows:

No alternative flows were identified.

5.1.3.1.4 Post-conditions:

5.1.3.1.4.1 Success End State:

PostC5.3.1 - A.U. is notified that request has been successfully transmitted.
PostC5.3.2 -

5.1.3.1.4.2 Failure End State:

PostC5.3.3 - Delivery of notification message to AU, indicating request has failed.

5.1.3.2 Use case 3.2 – Develop UDPP measures

Summary:

This Use Case is the continuity of the previous one. It is triggered when Use Case 3.1 has been successfully conducted.

5.1.3.2.1 Preconditions:

PreC3.2.1 – success of previous part 5.3.1.
PreC3.2.2 – AU pre-allocated slot-swap request has been received by N.M.

5.1.3.2.2 Actors:

Main actors:

AU and NM have a major role in the development and implementation of the “Pre-allocated ATFM slot swap” process. They develop the adequate measures as described in the operating method below.

Secondary actors:

APT, ANSPs, and FMPs are informed of the issue of the use-case, if they are impacted.

5.1.3.2.3 Operating method:

Table below provides the high level description of the new operating method for the development of the “Pre-allocated ATFM slot swap” process, in the form of successive steps to be implemented as it progresses into the system.

5.1.3.2.3.1 Main Flow:

| Step | Actor | Action | Tool |
|---------|-------|---|--------------|
| UC3.2.1 | N.M. | Request is taken over. | NOP helpdesk |
| UC3.2.2 | N.M. | Impact of the slot-swap on the network is assessed. | ETFMS NID |
| UC3.2.3 | N.M. | If the impact on the network is satisfying, slot-swap is accepted. If not demand is rejected. | ETFMS NID |
| UC3.2.4 | N.M. | Acceptance/ reject is made available to A.U. | NOP helpdesk |
| UC3.2.5 | | | |
| UC3.2.6 | | | |
| UC3.2.7 | | | |
| UC3.2.8 | | | |
| UC3.2.9 | | | |

5.1.3.2.3.2 Alternative Flows:

No alternative flow was identified.

5.1.3.2.4 Post-conditions:

5.1.3.2.4.1 Success End State:

PostC3.2.1 - A.U. is notified of validation of the request.
PostC3.2.2 -
PostC3.2.3 -

5.1.3.2.4.2 Failure End State:

PostC3.2.3 - AU is notified that request was rejected with reason (e.g. time is too close to departure and the request cannot be processed; flight is no longer regulated: regulation was cancelled during processing).

5.1.3.3 Use case 3.3 – Collaboratively agree and implement UDPP measure

Summary:

This Use Case is the continuity of the previous one. It is triggered when Use Case 3.2 has been successfully conducted.

5.1.3.3.1 Preconditions:

PreC3.3.1 – success of previous part 5.3.2.
PreC3.3.2 – The pre-allocated slot swap has been validated by N.M.

5.1.3.3.2 Actors:

Ac1 - Airspace User

AU receives the response for the “Pre-allocated ATFM slot swap” request, and implements the adequate measures as described in the operating method below.

Ac2 - Network Manager

NM implements the adequate measures as described in the operating method below.

Ac3 - ATC

ATC receives the FPL change notification.

5.1.3.3.3 Operating method:

Table below provides the high level description of the new operating method for “Pre-allocated ATFM slot swap” process, in the form of successive steps to be implemented as it progresses into the system.

5.1.3.3.3.1 Main Flow:

| Step | Actor | Action | Tool |
|---------|-------|--|---------------|
| UC3.3.1 | N.M. | The N.M. system processes the slot-swap between the 2 CTOs. Flight “B” is forced to its new CTO. Flight “A” gets the old Flight “B” CTO. | ETFMS |
| UC3.3.2 | N.M. | New CTOT is allocated to Flight “B”. Flight “B” is in “Forced Slot” status. | ETFMS |
| UC3.3.3 | N.M. | New CTOT is allocated to Flight “A”. Flight “A” gets into pre-allocated slot status. System Development needs be to maintain Flight “A” new CTO in the Flight list, although the system would search for automatic improvement as Flight “A” still has an EOBT unchanged. | ETFMS |
| UC3.3.4 | N.M. | Flights “A” and “B” CTOTs are updated into the ETFMS Flight List. | ETFMS |
| UC3.3.5 | N.M. | A Slot Revision Message for Flight “B” with new CTOT is sent to AU, APT, ANSPs, and FMPs. | ETFMS |
| UC3.3.6 | A.U. | Receives the Slot Revision Message for Flight “B”. | AU own system |
| UC3.3.7 | A.U. | Takes necessary action with regards to operations, according to current procedure for a slot-swap (informs crew, station platform for handing services, etc.) | AU own system |
| UC3.3.8 | | | |
| UC3.3.9 | | | |

5.1.3.3.3.2 Alternative Flows:

No alternative flows were identified.

5.1.3.3.4 Post-conditions:

5.1.3.3.4.1 Success End State:

PostC3.3.1 - Delivery of a SRM for both flights

PostC3.3.2 -

PostC3.3.3 -

PostC3.3.4 -

PostC3.3.5 -

5.1.3.3.4.2 Failure End State:

PostC3.2.6 -
PostC3.2.7 -
PostC3.2.8 -

5.1.4 USE CASE 4 – Most Penalising Delay

Summary:

It is 06:40 on day of operations.

- Flight “A” is departing from Paris-CDG with EOBT 08:00 / ETOT 08:20, landing in Roma. Flight “A” is subject to a regulation in Roma, CTOT 08:40, NM delay is 20min. Flight “A” is in “Slot-issued” state.

- Flight “B” is scheduled to depart from Paris-CDG with EOBT 08:30 / ETOT 08:50, landing in London. It is affected by a regulation on its route to London, CTOT = 09:00, NM delay is 10min. Flight “B” is in “Slot-issued” state.

- Flights “A” and “B” don’t share the same Most Penalising Regulation, they cannot be swapped.

- Paris is experiencing stormy weather, and delay at departure CDM APT is 35min. The pre-departure sequence system revises the Flights TTOT: new Flight “A” TTOT = 08:55; new Flight “B” TTOT= 09:25.

- With new system, NM takes into consideration that APT delay is the most penalising, and allows slot swap between “A” and “B” as if they would share the same MPR. This new process is called the “Most Penalising Delay” slot swap.

- It is 07:00 UTC on day of operations.
- AF5461 is departing from CDM airport PARIS Charles de Gaulle (CDG) with EOBT 08:00, ETOT 08:20, landing in Roma (FCO) with an ETA 10:20.
This flight is subject to an en-route regulation leading to a 20min delay. Its ATFM slot (CTOT 08:40) has been issued at 06:00. AF5461 is in “Slot-issued” state.
- AF8849 is scheduled to depart from Paris-CDG with EOBT 08:30 / ETOT 08:50, landing in London. It is affected by a regulation on its route to London, CTOT = 09:15, leading to a 25min delay. AF8849 is in “Slot-issued” state.
- AF5461 and AF8849 don’ share the same Most Penalising Regulation, they cannot be swapped according to the current operational procedure.
- Paris is experiencing stormy weather, and delay at departure CDM APT is 35min. The pre-departure sequence system revises the Flights TTOT: new AF5461 TTOT = 08:55; new AF8849 TTOT= 09:25.
- From the Aircraft Operator’s point of view, AF8849 is more important. He wants to prioritise it by swapping with AF5461. If he does, AF8849’s new TTOT will be 08:55, only 5 min later than filled ETOT, then AF8849 will arrive almost in time, only 5 min later than initial ETA.
- With new system, NM takes into consideration that APT delay is the most penalising, and allows slot swap between AF5461 and AF8849 as if they would share the same MPR. This new process is called the “Most Penalising Delay” slot swap.

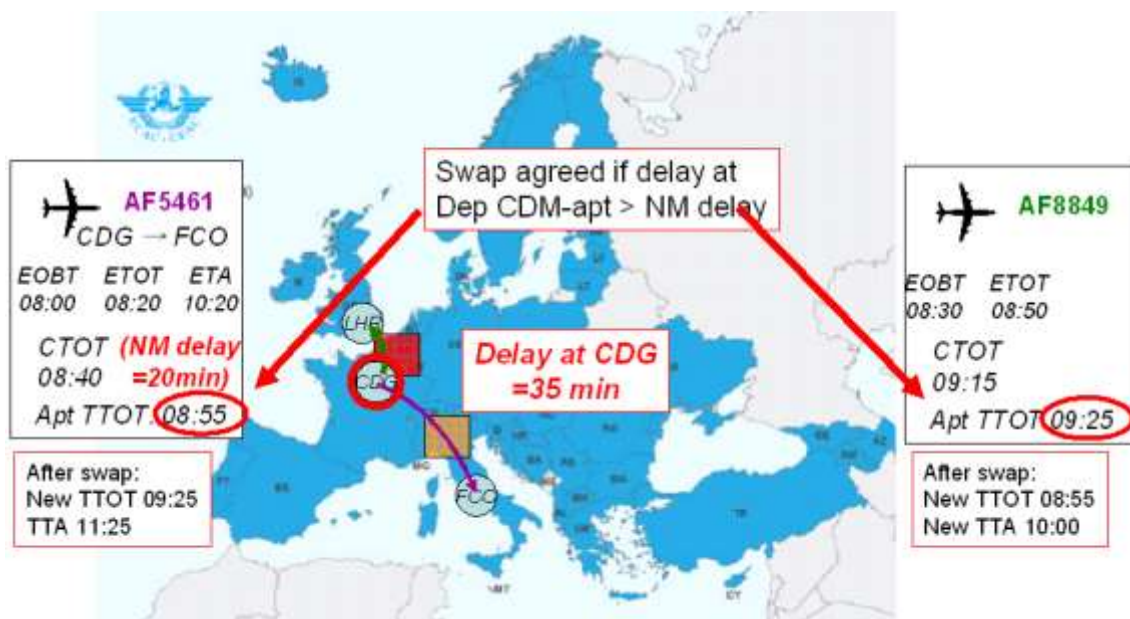

Figure 37: Use Case 4: ATFM Most Penalising Delay.

5.1.4.1 Use case 4.1 – Identify the need and initiate the UDPP process

Summary:

This Use Case is triggered when the AU experiences a need for a “Most Penalising Delay ATFM slot swap” on day of operations.

E.g.: AU identifies the need within its operations for Flight “A” to land earlier, by getting the Flight “B”’s slot. It initiates a Most Penalising Delay ATFM slot-swap between Flight “A” and Flight “B”.

5.1.4.1.1 Preconditions:

PreC4.1.1 – Flights “A” and “B” are in Slot-issued status.

PreC4.1.2 – Flights “A” and “B” are not in Forced Slot Status

PreC4.1.3 – Flights “A” and “B” don’t share the same Most Penalising Regulation

PreC4.1.4 – Flights “A” and “B” depart from the same CDM airport.

PreC4.1.5 – Flights “A” and “B” are both affected by delay at their Departure CDM-Airport, which is higher than delay caused by their respective MPR.

5.1.4.1.2 Actors:

Ac1 - Airspace User

He is responsible for the monitoring of his flights operations, the assessment of the level of deterioration, and triggering the UDPP process for the “Most Penalising Delay ATFM slot swap”.

Ac2 - Network Manager

NM has no role in the identification and initiation of the “Most Penalising Delay ATFM slot swap” process.

Ac3 - ATC

ATC has no role in the identification and initiation of the “Most Penalising Delay ATFM slot swap” process.

5.1.4.1.3 Operating method:

Table below provides the high level description of the new operating method for the “Most Penalising Delay ATFM slot swap” process, in the form of successive steps to be implemented as it progresses into the system.

5.1.4.1.4 Main Flow:

| Step | Actor | Action | Tool |
|---------|-------|--|-----------------|
| UC4.1.1 | A.U. | Identifies Flight “A” and Flight “B” as candidates for a “Most Penalising Delay ATFM slot swap”. See pre-conditions here-above for candidate flights. | CHMI / NOP |
| UC4.1.2 | A.U. | Processes the request to NM. The request must be submitted with all necessary information for NM to treat it. | (NOP helpdesk?) |
| UC4.1.3 | A.U. | Is notified that the request has been submitted successfully. | (NOP helpdesk?) |
| UC4.1.4 | | | |
| UC4.1.5 | | | |
| UC4.1.6 | | | |
| UC4.1.7 | | | |
| UC4.1.8 | | | |
| UC4.1.9 | | | |

5.1.4.1.4.1 Alternative Flows:

No alternative flows were identified.

5.1.4.1.5 Post-conditions:

5.1.4.1.6 Success End State:

PostC4.1.1 - A.U. is notified that request has been successfully transmitted.
PostC4.1.2 -

5.1.4.1.6.1 Failure End State:

PostC4.1.3 – AU is notified that request has failed to be transmitted.

5.1.4.2 Use case 4.2 – Develop UDPP measures

Summary:

This Use Case is the continuity of the previous one. It is triggered when Use Case 4.1 has been successfully conducted.

5.1.4.2.1 Preconditions:

PreC4.2.1 – success of previous part 5.4.1
PreC4.2.2 –
PreC4.2.3 –
PreC4.2.4 –

5.1.4.2.2 Actors:

Main actors:

APT, AU and NM have a major role in the development and implementation of the “Most Penalising Delay ATFM slot swap” process. They develop the adequate measures as described in the operating method below.

Secondary actors:

ANSPs, and FMPs are informed of the issue of the use-case, if they are impacted.

5.1.4.2.3 Operating method:

Table below provides the high level description of the new operating method for the development of the “Most Penalising Delay ATFM slot swap” process, in the form of successive steps to be implemented as it progresses into the system.

5.1.4.2.3.1 Main Flow:

| Step | Actor | Action | Tool |
|---------|-------|---|--------------|
| UC4.2.1 | N.M. | Request is taken over. | NOP helpdesk |
| UC4.2.2 | N.M. | Check is made that delay caused by CDM DEP airport is the Most Important Delay | NOP ops |
| UC4.2.3 | N.M. | Impact of the slot-swap on the network is assessed. | ETFMS NID |
| UC4.2.4 | N.M. | If the impact on the network is satisfying, slot-swap is accepted. If not demand is rejected. | ETFMS NID |
| UC4.2.5 | N.M. | Acceptance/ reject is made available to A.U. | NOP helpdesk |
| UC4.2.6 | | | |
| UC4.2.7 | | | |
| UC4.2.8 | | | |
| UC4.2.9 | | | |

5.1.4.2.3.2 Alternative Flows:

No alternative flow was identified.

5.1.4.2.4 Post-conditions:

5.1.4.2.4.1 Success End State:

PostC4.2.1 - A.U. is notified of validation of the request.

PostC4.2.2 -

PostC4.2.3 -

5.1.4.2.4.2 Failure End State:

PostC4.2.4 - A.U. is notified of rejection of the request with reason.

PostC4.2.5 -

5.1.4.3 Use case 4.3 – Collaboratively agree and implement UDPP measure

Summary:

This Use Case is the continuity of the previous one. It is triggered when Use Case.4.2 has been successfully conducted.

5.1.4.3.1 Preconditions:

PreC4.3.1 – success of previous part 5.4.2

PreC4.3.2 –

PreC4.3.3 –
PreC4.3.4 –

5.1.4.3.2 Actors:

Main actors:

APT, AU and NM have a major role in the development and implementation of the “Most Penalising Delay ATFM slot swap” process. They develop the adequate measures as described in the operating method below.

Secondary actors:

ANSPs, and FMPs are informed of the issue of the use-case, if they are impacted.

5.1.4.3.3 Operating method:

Table below provides the high level description of the new operating method for the development of the “Most Penalising Delay ATFM slot swap” process, in the form of successive steps to be implemented as it progresses into the system.

5.1.4.3.3.1 Main Flow:

| Step | Actor | Action | Tool |
|---------|-------|--|---------------|
| UC4.3.1 | N.M. | The N.M. system processes the slot-swap between the 2 flights. Flight “A” gets the old Flight “B” departure time. | ETFMS |
| UC4.3.2 | N.M. | New CTOT is allocated to Flight “B”, forced to its new departure time. | ETFMS |
| UC4.3.3 | N.M. | New CTOT is allocated to Flight “A”, forced to its new departure time. | ETFMS |
| UC4.3.4 | N.M. | Flights “A” and “B” CTOTs are updated into the ETFMS Flight List. | ETFMS |
| UC4.3.5 | N.M. | Slot Revision Messages for Flights “B” and “A” with new CTOT are sent to AU, APT, ANSPs, and FMPs. | ETFMS |
| UC4.3.6 | A.U. | Receives the Slot Revision Messages for Flight “A” and “B”. | AU own system |
| UC4.3.7 | A.U. | Takes necessary action with regards to operations, according to current procedure for a slot-swap (informs crew, station platform for handling services, etc.) | AU own system |
| UC4.3.8 | | | |
| UC4.3.9 | | | |

5.1.4.3.3.2 Alternative Flows:

No alternative flows were identified.

5.1.4.3.4 Post-conditions:

5.1.4.3.4.1 Success End State:

PostC4.3.1 – SRM is received by concerned parties.
PostC4.3.2 -
PostC4.3.3 -

5.1.4.3.4.2 Failure End State:

PostC4.3.4 -
PostC4.3.5 -
PostC4.3.6-

5.2 Operational Scenario 2 –Demand/Capacity imbalance under degraded situation at Departure CDM Airport

December, bad weather conditions with snow reduces capacity at departure CDM airport. A severe Demand / Capacity imbalance impacts the Departure CDM airport. The airport system calculates the ATC Target Take-Off Time (TTOT) and allocates TSATs to aircraft in the Pre-Departure Sequence.

To reach their strategy, Airspace Users make use of the UDPP-Departure capabilities, so that their most important flights can be prioritised.

5.2.1 USE CASE 5 – Departure Reference-Time Reordering

Summary:

- It is 9:00 UTC. As a consequence of high demand / capacity imbalance at the CDM APT, all flights are seriously delayed.
- AFR FOC identifies its most important flights to give them priority in the pre-departure sequence.
- AFR FOC reorganises a sample of its own flights according to the required rank for treatment process, and then triggers the Departure Reference-Time Reordering.
- CDM APT pre-departure sequence is recalculated accordingly to new rank for treatment process. However reordered flights will not be able to depart ahead of their Scheduled departure time (SOBT), nor their allocated CTOT.
- New TSATs are made available to all in the PDS flight list.

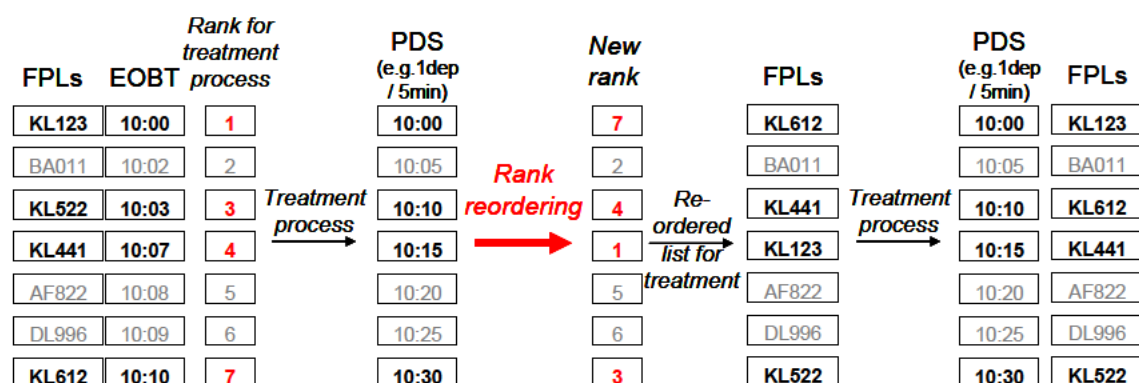

Figure 38: Use Case 5: Departure Reference-Time Reordering.

5.2.1.1 Use case 5.1 – Identify the need and initiate the UDPP process

Summary:

This Use Case is triggered when the AU experiences a need for an "Departure Reference-Time Reordering" on day of operations.

e.g.: It is stormy day at Departure airport. A.U. is experiencing delays and wishes to re-organise the order of its flights to better coordinate for connecting passengers.

Flights predeparture sequence list;
swappable flights are green

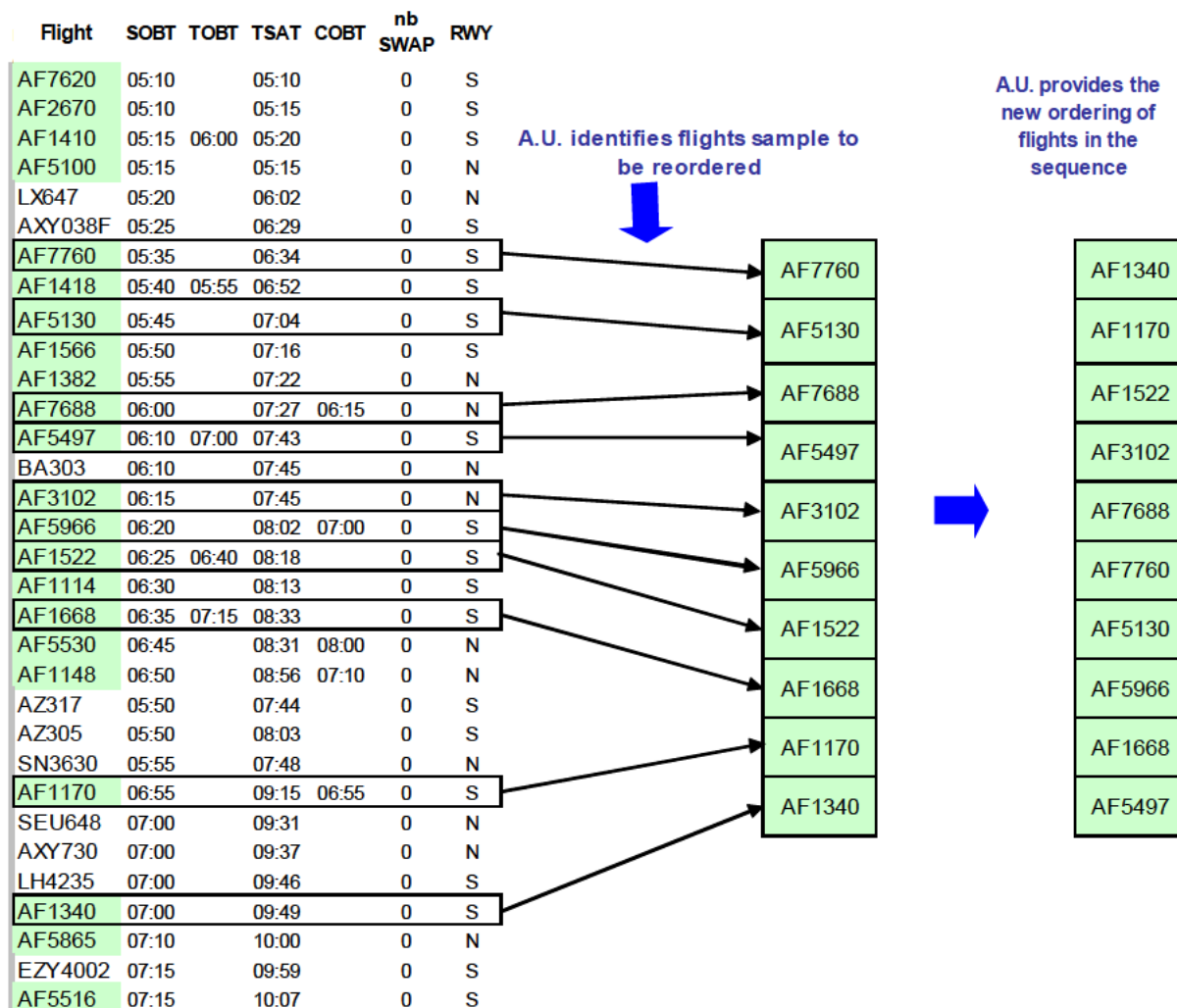

Figure 39: Use Case 5: an AU example of Departure Reference-Time Reordering.

5.2.1.1.1 Preconditions:

- PreC5.1.1 – TSAT does need to be issued to initiate the UDPP process
- PreC5.1.2 – reordering must be requested no later than x min before departure (e.g. 15 min location specific)
- PreC5.1.3 –
- PreC5.1.4 –

5.2.1.1.2 Actors:

Ac1 - Airspace User

He is responsible for the monitoring of his flights operations, the assessment of the level of deterioration, and triggering the UDPP process for the "Reference-time Departure reordering".

Ac2 - Network Manager

NM doesn't have any role in the initiation of the "Reference-time Departure reordering" process.

Ac3 - ATC

ATC doesn't have any role in the initiation of the "Reference-time Departure reordering" process.

Ac4 - APT

APT doesn't have any role in the initiation of the "Reference-time Departure reordering" process.

5.2.1.1.3 Operating method:

Table below provides the high level description of the new operating method for the "Reference-time Departure reordering" process, in the form of successive steps to be implemented as it progresses into the system.

5.2.1.1.3.1 Main Flow:

| Step | Actor | Action | Tool |
|---------|-------|---|------|
| UC5.1.1 | | Triggering event | |
| UC5.1.2 | A.U. | Identifies candidate flights for a "Reference-time Departure reordering". See pre-conditions here-above for candidate flights. | |
| UC5.1.3 | A.U. | Processes the request to APT CDM or APOC. The request must be submitted with all necessary information to treat it. | |
| UC5.1.4 | A.U. | Is notified that the request has been submitted successfully. | |
| UC5.1.5 | | | |
| UC5.1.6 | | | |
| UC5.1.7 | | | |
| UC5.1.8 | | | |
| UC5.1.9 | | | |

5.2.1.1.3.2 Alternative Flows:

No alternative flows were identified.

5.2.1.1.4 Post-conditions:

5.2.1.1.4.1 Success End State:

PostC5.1.1 - A.U. is notified that request has been successfully transmitted.

PostC5.1.2 -

5.2.1.1.4.2 Failure End State:

PostC5.1.3 - Delivery of notification message to AU, indicating request has failed.

5.2.1.2 Use case 5.2 – Develop UDPP measures

Summary:

This Use Case is the continuity of the previous one. It is triggered when Use Case 5.1 has been successfully conducted.

5.2.1.2.1 Preconditions:

PreC5.2.1 – success of previous part 5.5.1

PreC5.2.2 –
PreC5.2.3 –
PreC5.2.4 –

5.2.1.2.2 Actors:

Main actors:

CDM APT, AU and NM have a major role in the development of the "Departure Reference-Time Reordering" process. They develop the adequate measures as described in the operating method below.

Secondary actors:

ANSPs, and FMPs are informed of the issue of the use-case, if they are impacted.

5.2.1.2.3 Operating method:

Table below provides the high level description of the new operating method for the development of the "Departure Reference-Time Reordering" process, in the form of successive steps to be implemented as it progresses into the system.

5.2.1.2.3.1 Main Flow:

| Step | Actor | Action | Tool |
|---------|---------|--|------|
| UC5.2.1 | CDM APT | Check of the validity (constraints) | |
| UC5.2.2 | CDM APT | Acknowledgement (acceptance / rejection) | |
| UC5.2.3 | | | |
| UC5.2.4 | | | |
| UC5.2.5 | | | |
| UC5.2.6 | | | |
| UC5.2.7 | | | |
| UC5.2.8 | | | |
| UC5.2.9 | | | |

5.2.1.2.3.2 Alternative Flows:

No alternative flows were identified.

5.2.1.2.4 Post-conditions:

5.2.1.2.4.1 Success End State:

PostC5.2.1 – A.U.'s request is accepted
PostC5.2.2 –
PostC5.2.3 –

5.2.1.2.5 Failure End State:

PostC5.2.4 – A.U. receives reject message with explanation
PostC5.2.5 –

5.2.1.3 Use case 5.3 – Collaboratively agree and implement UDPP measure

Summary:

This Use Case is the continuity of the previous one. It is triggered when Use case 5.2 has been successfully conducted.

5.2.1.3.1 Preconditions:

- PreC5.3.1 – success of previous part 5.5.2
- PreC5.3.2 –
- PreC5.3.3 –
- PreC5.3.4 –

5.2.1.3.2 Actors:

Main actors:

CDM APT, AU and NM have a major role in the implementation of the “Departure Reference-Time Reordering” process. They develop the adequate measures as described in the operating method below.

Secondary actors:

ANSPs, and FMPs are informed of the issue of the use-case, if they are impacted.

5.2.1.3.3 Operating method:

Table below provides the high level description of the new operating method for the development of the “Departure Reference-Time Reordering” process, in the form of successive steps to be implemented as it progresses into the system.

5.2.1.3.3.1 Main Flow:

| Step | Actor | Action | Tool |
|---------|---------|---|------|
| UC5.3.1 | CDM APT | The system updates the sequencing list | |
| UC5.3.2 | | Information is made available to all actors | |
| UC5.3.3 | | | |
| UC5.3.4 | | | |
| UC5.3.5 | | | |
| UC5.3.6 | | | |
| UC5.3.7 | | | |
| UC5.3.8 | | | |
| UC5.3.9 | | | |

5.2.1.3.3.2 Alternative Flows:

No alternative flows were identified.

5.2.1.3.4 Post-conditions:

5.2.1.3.4.1 Success End State:

- PostC5.3.1 - Departure sequence is changed as A.U. requested
- PostC5.3.2 - Information is made available to all actors

PostC5.3.3 - other A.U.'s flights keep their place in the sequence

5.2.1.3.5 Failure End State:

PostC5.3.4 - nothing changes in the pre-departure sequence

PostC5.3.5 - A.U. receives reject message with explanation

PostC5.3.6-

5.2.2 USE CASE 6 – First Priority for Departure

Summary:

- As a consequence of high demand / capacity imbalance at the CDM APT, all flights are seriously delayed. However, flight KL612 is of high importance for KLM FOC, as 17 passengers will miss their connection because of the delay at departure.
- KLM FOC then decides to trigger the First Priority for Departure.
- KL612 gets first priority in the RWY slot allocation PDS process, amongst other KLM flights.
- Within KLM flights in the CDM APT pre-departure sequence, KL612 gets first place for treatment process, and other KLM flights are cascaded down amongst KLM allocated RWY slots.

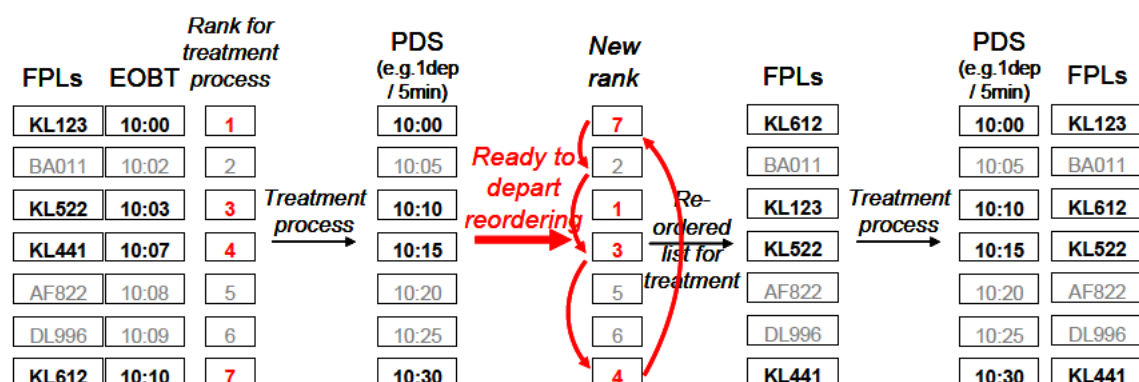

Figure 40: Use Case 6: First Priority for Departure.

5.2.2.1 Use case 6.1 – Identify the need and initiate the UDPP process

Summary:

This Use Case is triggered when the AU experiences a need for improving one specific flight at the best possible RWY slot on day of operations.

E.g.: Flight "A" is delayed because of APT operations. A.U. wishes to improve its order in the APT departure sequence before its other flights. A.U. triggers the First Priority for Departure.

5.2.2.1.1 Preconditions:

PreC6.1.1 – Flight "A" is allocated a T-SAT in the departure CDM airport PDS

PreC6.1.2 –

PreC6.1.3 –

PreC6.1.4 –

5.2.2.1.2 Actors:

Ac1 - Airspace User

He is responsible for the monitoring of his flights operations, the assessment of the level of deterioration, and triggering the UDPP process for the First Priority for Departure.

Ac2 - Network Manager

NM has no role in the identification and initiation of the First Priority for Departure process.

Ac3 - ATC

ATC has no role in the identification and initiation of the First Priority for Departure process.

5.2.2.1.3 Operating method:

Table below provides the high level description of the new operating method for the First Priority for Departure reordering process, in the form of successive steps to be implemented as it progresses into the system.

5.2.2.1.3.1 Main Flow:

| Step | Actor | Action | Tool |
|---------|----------|--|------|
| UC6.1.1 | A.U. (1) | Identifies Flight "A" to be prioritised". | |
| UC6.1.2 | A.U. (1) | Processes the request on its tool interface: | |
| UC6.1.3 | A.U. (1) | Is notified that the proposal has been submitted successfully. | |
| UC6.1.4 | | | |
| UC6.1.5 | | | |
| UC6.1.6 | | | |
| UC6.1.7 | | | |
| UC6.1.8 | | | |
| UC6.1.9 | | | |

5.2.2.1.3.2 Alternative Flows:

No alternative flows were identified.

5.2.2.1.4 Post-conditions:

5.2.2.1.4.1 Success End State:

PostC6.1.1 - A.U. is notified that proposal has been successfully transmitted.

PostC6.1.2 -

5.2.2.1.4.2 Failure End State:

PostC6.1.3 - Delivery of notification message to AU, indicating proposal has failed.

5.2.2.2 Use case 6.2 – Develop UDPP measures

Summary:

This Use Case is the continuity of the previous one. It is triggered when Use Case 6.1 has been successfully conducted.

5.2.2.2.1 Preconditions:

PreC6.2.1 – success of previous part 6.1.1

5.2.2.2.2 Actors:

Main actors:

AU and APT CDM or APOC have a major role in the development and implementation of First Priority for Departure reordering process. They develop the adequate measures as described in the operating method below.

Secondary actors:

No secondary actors at this stage.

5.2.2.2.3 Operating method:

Table below provides the high level description of the new operating method for the First Priority for Departure reordering process, in the form of successive steps to be implemented as it progresses into the system.

5.2.2.2.3.1 Main Flow:

| Step | Actor | Action | Tool |
|---------|----------------|---|------|
| UC6.2.1 | APT CDM / APOC | The CDM APT system searches for all flights from the same AU being allocated an earlier RWY slot | |
| UC6.2.2 | APT CDM / APOC | Flight "A" is placed first in the treatment rank flight list for RWY slot allocation, amongst other flights from same AU. | |
| UC6.2.3 | APT CDM / APOC | Other flights from the same AU are cascaded down in the treatment rank flight list for RWY slot allocation | |
| UC6.2.4 | | | |
| UC6.2.5 | | | |
| UC6.2.6 | | | |
| UC6.2.7 | | | |
| UC6.2.8 | | | |

5.2.2.2.3.2 Alternative Flows:

No alternative flow was identified.

5.2.2.2.4 Post-conditions:

5.2.2.2.4.1 Success End State:

PostC6.2.1 - A.U.'s request is accepted
PostC6.2.2 -

5.2.2.2.4.2 Failure End State:

PostC6.2.3 - A.U. receives reject message with explanation

5.2.2.3 Use case 6.3 – Collaboratively agree and implement UDPP measure

Summary:

This Use Case is the continuity of the previous one. It is triggered when Use Case 6.2 has been successfully conducted.

5.2.2.3.1 Preconditions:

PreC6.3.1 – success of previous part 6.2.2
PreC6.3.2 –
PreC6.3.3 –
PreC6.3.4 –

5.2.2.3.2 Actors:

Main actors:

AU and APT CDM or APOC have a major role in the development and implementation of the First Priority for Departure reordering process. They develop the adequate measures as described in the operating method below.

Secondary actors:

NM, ANSPs, and FMPs are informed of the issue of the use-case, if they are impacted.

5.2.2.3.3 Operating method:

Table below provides the high level description of the new operating method for the implementation of the First Priority for Departure, in the form of successive steps to be implemented as it progresses into the system.

5.2.2.3.4 Main Flow:

| Step | Actor | Action | Tool |
|---------|---------|--|------|
| UC6.3.1 | CDM APT | The system updates the pre-departure sequencing list | |
| UC6.3.2 | CDM APT | Information is made available to all actors | |
| UC6.3.3 | | | |
| UC6.3.4 | | | |
| UC6.3.5 | | | |
| UC6.3.6 | | | |
| UC6.3.7 | | | |
| UC6.3.8 | | | |
| UC6.3.9 | | | |

5.2.2.3.4.1 Alternative Flows:

No alternative flows were identified.

5.2.2.3.5 Post-conditions:

5.2.2.3.5.1 Success End State:

PostC6.3.1 - Departure sequence is changed as A.U. requested.
PostC6.3.2 - Information is made available to all actors
PostC6.3.3 - other A.U.'s flights keep their place in the sequence

5.2.2.3.5.2 Failure End State:

PostC6.3.3 - Delivery of notification message to AU, indicating rejection.

5.2.3 USE CASE 7 –Upwards Cascade on Departure Cancellation

Summary:

- As a consequence of high demand / capacity imbalance at the CDM APT, all flights are seriously delayed. KLM FOC decides to cancel flight KL522, which is of least importance on a strategic point of view, so as to cascade up and reduce delay on its other flights.
- KLM FOC then decides to trigger the PDS ownership on cancellation reordering process.
- When the Upwards Cascade on Departure Cancellation process is triggered, all other flights KLM flights are improved automatically by the system, by substitution.
Constraint: Flights cannot be improved in the departure sequence more than their requested departure time. Regulated flights cannot be improved in the departure sequence more than their Slot Tolerance Window permits.
- CDM APT pre-departure sequence flight list is updated with recalculated TSATs.

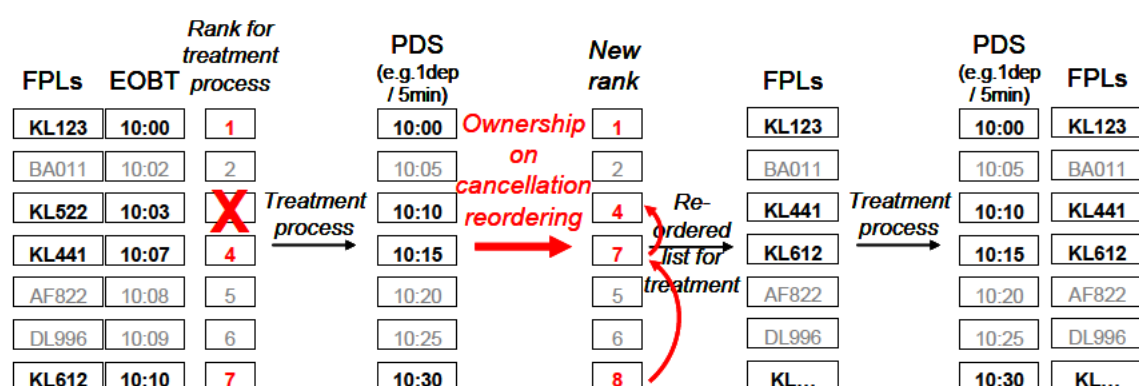

Figure 41: Use Case 7: PDS Ownership on cancellation.

5.2.3.1 Use case 7.1 – Identify the need and initiate the UDPP process

Summary:

This Use Case is triggered when the AU experiences a need for a flight cancellation on day of operations.

E.g.:

A severe Demand / Capacity imbalance impacts traffic. AU decides to cancel Flight "A", and initiates the "PDS ownership on cancellation reordering" process.

5.2.3.1.1 Preconditions:

PreC7.1.1 – Cancellation must be requested no later than x min before departure (location specific)

PreC7.1.2 –

5.2.3.1.2 Actors:

Ac1 - Airspace User

He is responsible for the monitoring of his flights operations, the assessment of the level of deterioration, and triggering the UDPP process for "PDS ownership on cancellation reordering" process.

Ac2 - Network Manager

NM has no role in the identification of flight cancellation and initiation of “PDS ownership on cancellation reordering” process.

Ac3 - ATC

ATC has no role in the identification of flight cancellation and initiation of the “PDS ownership on cancellation reordering” process.

5.2.3.1.3 Operating method:

Table below provides the high level description of the new operating method for the Upwards Cascade on Departure Cancellation process, in the form of successive steps to be implemented as it progresses into the system.

5.2.3.1.3.1 Main Flow:

| Step | Actor | Action | Tool |
|---------|-------|--|-------------|
| UC7.1.1 | A.U. | Identifies Flight “A” as candidate for a “PDS ownership on cancellation reordering” process. | |
| UC7.1.2 | A.U. | Processes the cancellation | CNL message |
| UC7.1.3 | A.U. | Is notified that the request has been submitted successfully. | |
| UC7.1.4 | | | |
| UC7.1.5 | | | |
| UC7.1.6 | | | |
| UC7.1.7 | | | |
| UC7.1.8 | | | |
| UC7.1.9 | | | |

5.2.3.1.3.2 Alternative Flows:

No alternative flow was identified.

5.2.3.1.4 Post-conditions:

5.2.3.1.4.1 Success End State:

PostC7.1.1 – A.U. is notified that CNL has been successfully transmitted.
PostC7.1.2 -

5.2.3.1.4.2 Failure End State:

PostC7.1.3 -
PostC7.1.4 -
PostC7.1.5 -

5.2.3.2 Use case 7.2 – Develop UDPP measures

Summary:

This Use Case is the continuity of the previous one. It is triggered when Use Case 7.1 has been successfully conducted.

5.2.3.2.1 Preconditions:

PreC7.2.1 – success of previous part 7.1.1

PreC7.3.2 – in case substitute flight is regulated, it should not be improved out of its Slot Tolerance Window.

PreC7.3.3 – substitute flight should not be improved more than its requested time of departure.

PreC7.3.4 – substitute flight should be improved xxx min before his departure, in line with current APT procedures

5.2.3.2.2 Actors:

Main actors:

AU and APT CDM or APOC have a major role in the development and implementation of the “PDS ownership on cancellation reordering” process. They develop the adequate measures as described in the operating method below.

Secondary actors:

No secondary actors at this stage.

5.2.3.2.3 Operating method:

Table below provides the high level description of the new operating method for “PDS ownership on cancellation reordering” process, in the form of successive steps to be implemented as it progresses into the system.

5.2.3.2.3.1 Main Flow:

| Step | Actor | Action | Tool |
|---------|---------|--|------|
| UC7.2.1 | APT CDM | The system automatically processes the substitutions with the same AU’s other flights in the pre-departure sequence. Substitution of flights is subject to constraints as detailed in the pre-conditions. | |
| UC7.2.2 | APT CDM | Substitution cascade ends when no substitution flight can be found by the system, according to the substitution rules. | |
| UC7.2.3 | | | |
| UC7.2.4 | | | |
| UC7.2.5 | | | |
| UC7.2.6 | | | |
| UC7.2.7 | | | |
| UC7.2.8 | | | |
| UC7.2.9 | | | |

5.2.3.2.3.2 Alternative Flows:

No alternative flow was identified.

5.2.3.2.4 Post-conditions:

5.2.3.2.4.1 Success End State:

PostC7.2.1 – at least one substitute flight could be found by the system, at the end of the substitution cascade processing.

PostC7.2.2 -

5.2.3.2.4.2 Failure End State:

PostC7.2.3 – no substitution flight would be found by the system.

5.2.3.3 Use case 7.3 – Collaboratively agree and implement UDPP measure

Summary:

This Use Case is the continuity of the previous one. It is triggered when Use Case 7.2 has been successfully conducted.

5.2.3.3.1 Preconditions:

PreC7.3.1 – success of previous part 7.2.2

5.2.3.3.2 Actors:

Main actors:

AU and APT CDM or APOC have a major role in the development and implementation of the “PDS ownership on cancellation reordering” process. They develop the adequate measures as described in the operating method below.

Secondary actors:

NM, ANSPs, and FMPs are informed of the issue of the use-case, if they are impacted.

5.2.3.3.3 Operating method:

Table below provides the high level description of the new operating method for the implementation of the “PDS ownership on cancellation reordering” process, in the form of successive steps to be implemented as it progresses into the system.

5.2.3.3.3.1 Main Flow:

| Step | Actor | Action | Tool |
|---------|---------|--|------|
| UC6.3.1 | CDM APT | The system updates the pre-departure sequencing list | |
| UC6.3.2 | CDM APT | Information is made available to all actors | |
| UC6.3.3 | | | |
| UC6.3.4 | | | |
| UC6.3.5 | | | |
| UC6.3.6 | | | |
| UC6.3.7 | | | |
| UC6.3.8 | | | |
| UC6.3.9 | | | |

5.2.3.3.3.2 Alternative Flows:

No alternative flows were identified.

5.2.3.3.4 Post-conditions:

5.2.3.3.4.1 Success End State:

PostC6.3.1 - Delivery of updated pre-departure sequence, indicating new TSATs.

PostC6.3.2 -

5.2.3.3.5 Failure End State:

PostC6.3.3 – nothing changes.

6 Requirements

This section describes the functional or qualitative requirements applicable to the operational process D60: “Apply and monitor the UDPP process” [5]. It develops the DOD requirements which are applicable to the Operational Focus Area UDPP addressed by this OSED.

The following high-level operational requirements have been identified in the DOD [5]:

| | |
|-------------|---|
| Identifier | REQ-07.02-DOD-0001.0009 |
| Requirement | Airspace Users among themselves can recommend to the Flow or Network Management a priority order for flights. |

6.1 Safety & Performance Requirements (SPR)

Safety requirements and performance requirements are described in the Safety and Performance Requirements document for UDPP [8].

6.2 Interoperability Requirements (IOP)

UDPP Step1 builds on existing systems and capabilities: the CDM environment for AUO-0103 and the ATFM Slot Swapping capability provided by the ETFMS for AUO-0101-A, and will use the already defined data exchange interfaces available. In each case, the need has not been identified to specify any additional Interoperability requirements.

6.3 Operational Requirements for UDPP

Note, the identifiers for requirements have been set to reflect the UDPP OI steps and the new operating features – see Figure 42.

6.3.1 Introducing the Requirement's Identifier

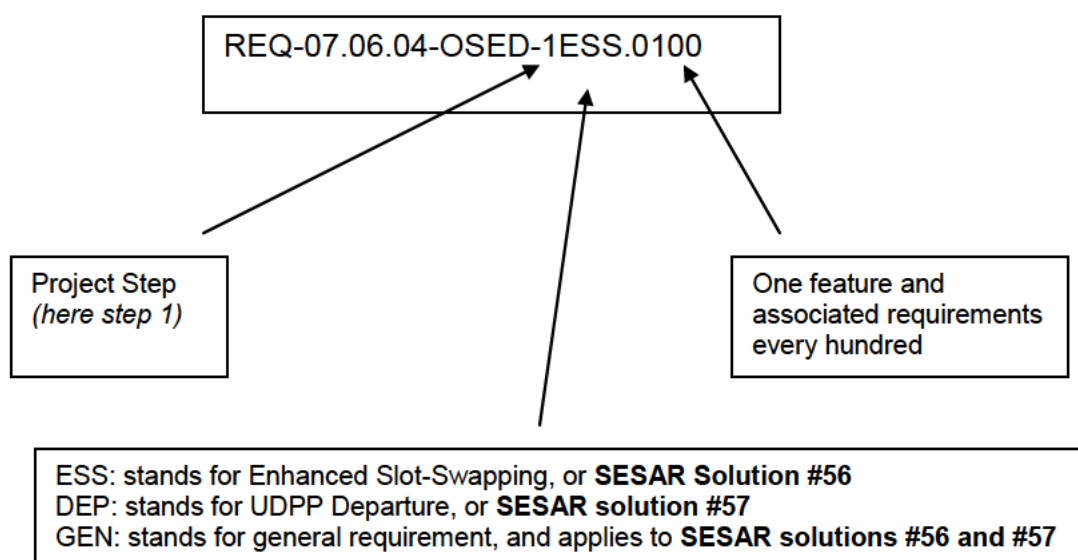

Figure 42: Explaining the notation of a requirement's identifier.

6.3.2 Requirements That Apply to Enhanced Slot Swapping and UDPP Departure (i.e., Both SESAR Solutions)

| | |
|-------------|---|
| Identifier | REQ-07.06.04-OSED-1GEN.0100 |
| Requirement | Airspace Users shall have the possibility to view the other Airspace Users' flights in the Flight List with associated information. |

| | |
|-------------|---|
| Identifier | REQ-07.06.04-OSED-1GEN.0200 |
| Requirement | Slot swapping shall be equitable by exchanging the place of the swapped flights in the flight list, while keeping the place of the other flights unchanged. |

The requirement above was deleted and re-expressed as performance requirement REQ-07.06.04-SPR-PERF.0130 in the SPR [8].

| | |
|-------------|---|
| Identifier | REQ-07.06.04-OSED-1GEN.0250 |
| Requirement | Slot swaps shall exchange the Time Reference of the swapped flights in the initial flight list used as the input list for the calculation of slot allocation. |

| | |
|------------|-----------------------------|
| Identifier | REQ-07.06.04-OSED-1GEN.0300 |
|------------|-----------------------------|

| | |
|-------------|--|
| Requirement | The processing time for a UDPP request shall not exceed 1 min for query, 1 min for submission, 2 min for execution of request. |
|-------------|--|

The requirement above was deleted and re-expressed as performance requirement REQ-07.06.04-SPR-PERF.0030 in the SPR [8].

| | |
|-------------|--|
| Identifier | REQ-07.06.04-OSED-1GEN.0400 |
| Requirement | Any airspace user shall have the possibility to trigger a slot-swap request. |

| | |
|-------------|---|
| Identifier | REQ-07.06.04-OSED-1GEN.0500 |
| Requirement | Slot swap requests to the Network Manager and CDM-airports, and related flight data, shall be made available to airspace users for post-ops analysis. |

6.3.3 Requirements for Enhanced ATFM Slot-Swapping (SESAR Solution #56)

| | |
|-------------|---|
| Identifier | REQ-07.06.04-OSED-1ESS.0000 |
| Requirement | Airspace users shall be provided with a means to facilitate the identification of swappable combinations of flights. The swappable flights shall be displayed in the 'subject flights' list. For each flight in the 'subject flight list', the Airspace User shall have the possibility to query 'candidate flights' for slot-swapping. The Airspace User shall have the possibility to choose a query for improvement, delay, or cancel. |

| | |
|-------------|--|
| Identifier | REQ-07.06.04-OSED-1ESS.0010 |
| Requirement | <p>Airspace users shall be provided with a means to set their own preferences for swap.</p> <p>The capability shall provide the possibility to define the following settings:</p> <ul style="list-style-type: none"> - include flights without commercial agreement - slots earlier than the ETOT - The minimum number of minutes to gain, - time margin to investigate the swap solutions for a flight, - allow a delay swap for a flight that is in REAdy status, - see if a slot swapped flight enters new regulations, - allow swapping pre-sequenced flights, - apply a time buffer to prevent from TTOT instability - set a time buffer for the NM eHelpdesk processing time - activate 'one request' multi-swap - activate 'pre-allocated' slot-swap - activate display of invalid solutions with explanation |

| | |
|-------------|---|
| Identifier | REQ-07.06.04-OSED-1ESS.0020 |
| Requirement | Airspace users shall be able to flag a priority level (high/low) on any swappable flight in the flight list so that high priority flights cannot be deteriorated. |

| | |
|-------------|---|
| Identifier | REQ-07.06.04-OSED-1ESS.0050 |
| Requirement | Airspace users shall be provided with a means to automatically submit a slot-swap request to the Network Manager. |

| | |
|-------------|---|
| Identifier | REQ-07.06.04-OSED-1ESS.0100 |
| Requirement | The Airspace User shall be enabled to request a multi-swap: slot-swap for a flight that was already previously swapped. |

| | |
|-------------|--|
| Identifier | REQ-07.06.04-OSED-1ESS.0101 |
| Requirement | The possibility shall exist for the Network Manager to limit the number of multi-swaps. The Maximum Number for swapping the same flight is adjustable (MAX SWAP Parameter). |

| | |
|-------------|--|
| Identifier | REQ-07.06.04-OSED-1ESS.0110 |
| Requirement | The airspace user shall be enabled to include a combination of two or three slot-swaps in one submitted request. |

At the time of writing all Step 1 validation activities have ceased. The 'pre-allocated slot swapping' and 'one request combined multi-swap' are not in SESAR solution #56. They have been transferred to NM for further development, validation and deployment. The requirements that are specific to these two concepts are marked as 'in progress', like the requirement given above.

| | |
|-------------|---|
| Identifier | REQ-07.06.04-OSED-1ESS.0200 |
| Requirement | The airspace user shall be able to swap a regulated flight in slot-issued status with a flight having an ATFM slot still in the pre-allocated status. |

| | |
|-------------|--|
| Identifier | REQ-07.06.04-OSED-1ESS.0201 |
| Requirement | The ETFMS system shall not freeze the CTO in ETFMS of swapped flights. |

The requirement above was deleted and re-expressed as performance requirement REQ-07.06.04-SPR-SAFT.0050 in the SPR [8].

| | |
|-------------|---|
| Identifier | REQ-07.06.04-OSED-1ESS.0300 |
| Requirement | Airspace Users shall be able to swap two flights departing from the same CDM-airport if delay generated by the airport is higher than delay caused by respective Most Penalising Regulation for both flights. |

| | |
|-------------|--|
| Identifier | REQ-07.06.04-OSED-1ESS.0400 |
| Requirement | An airspace user shall be able to identify a candidate flight to take the slot of another of his flights that will be cancelled. |

| | |
|-------------|--|
| Identifier | REQ-07.06.04-OSED-1ESS.0401 |
| Requirement | A slot reservation on cancellation shall be limited by a time-out. |

The requirement above was deleted because it became redundant when the operational concept changed.

| | |
|-------------|--|
| Identifier | REQ-07.06.04-OSED-1ESS.0500 |
| Requirement | The Airspace user shall be able to reflect business needs and constraints when requesting slot swap solutions. |

| | |
|-------------|---|
| Identifier | REQ-07.06.04-OSED-1ESS.0600 |
| Requirement | Network Manager shall either accept all or refuse all swaps in a single multi-swap request. |

| | |
|-------------|---|
| Identifier | REQ-07.06.04-OSED-1ESS.0700 |
| Requirement | The Network Manager shall respond to every swap slot request. |

6.3.4 Requirements for UDPP Departure (SESAR Solution #57)

| | |
|-------------|---|
| Identifier | REQ-07.06.04-OSED-1DEP.0100 |
| Requirement | An airspace user shall be able to reorganise the priority rank for treatment of flights in the A-CDM Reference-Time list. |

| | |
|-------------|--|
| Identifier | REQ-07.06.04-OSED-1DEP.0200 |
| Requirement | An airspace user shall be able to promote one specific flight among his own flights in the A-CDM Reference-Time list while cascading down his other flights. |

| | |
|-------------|--|
| Identifier | REQ-07.06.04-OSED-1DEP.0300 |
| Requirement | Airspace users shall be able to fill the vacated place of a cancelled flight with another flight, and continue the upwards cascade with other flights. |

6.4 Information Exchange Requirements

The ATFM Slot Swapping capability provided by ETFMS for AUO-0101-A uses existing systems and capabilities, and so the information exchange requirements in Table 9 already exist. Information exchange requirements have also been identified for departure swapping (i.e., AUO-0103).

[IER]

| Identifier | Name | Issuer | Intended Addressees | Information Element | Involved Operational Activities | Interaction Rules and Policy | Status | Rationale | Satisfied DOD Requirement Identifier | Service Identifier |
|-----------------------------|---|-----------------|---------------------|---------------------|---------------------------------|------------------------------|-------------|---|--------------------------------------|--------------------|
| IER-07.06.02-OSED-000S.0010 | Send ATFM Slots | Network Manager | Airspace user | | | | <Validated> | Already deployed for several years. | REQ-07.02-DOD-0001.0009<Partial> | |
| IER-07.06.02-OSED-000S.0020 | Propose Exchange of ATFM Slots | Airspace user | Network Manager | | | | <Validated> | Already deployed for several years. | REQ-07.02-DOD-0001.0009<Partial> | |
| IER-07.06.02-OSED-000S.0030 | Approve and publish exchange | Network Manager | Airspace user | | | | <Validated> | Already deployed for several years. | REQ-07.02-DOD-0001.0009<Partial> | |
| IER-07.06.02-OSED-000S.0040 | Refuse ATFM slot exchange | Network Manager | Airspace user | | | | <Validated> | Already deployed for several years. | REQ-07.02-DOD-0001.0009<Partial> | |
| IER-07.06.02-OSED-000S.0050 | Propose exchange of departure times | Airspace user | APOC | | | | <Validated> | Departure swapping has been deployed at Paris CDG | REQ-07.02-DOD-0001.0009<Partial> | |
| IER-07.06.02-OSED-000S.0060 | Approve and publish exchange of departure times | APOC | Airspace user | | | | <Validated> | Departure swapping has been deployed at Paris CDG | REQ-07.02-DOD-0001.0009<Partial> | |

Table 9: Information exchange requirements for OI steps AUO-0101-A and AUO-0103-A.

Note, the processes shown in Figure 1 are not entirely correct. The errors are as follows: when refusing to accept an ATFM slot swap, the Network Manager does not make a counter proposal; similarly, the APOC does not make a counter proposal if the departure time exchange is unacceptable. SWP07.02 is now aware of the need to update the process diagram.

7 References

List of the reference and applicable documents.

7.1 Applicable Documents

This OSED complies with the requirements set out in the following documents:

- [1] Template Toolbox 03.00.00
<https://extranet.sesarju.eu/Programme%20Library/SESAR%20Template%20Toolbox.dot>
- [2] Requirements and V&V Guidelines 03.00.00
<https://extranet.sesarju.eu/Programme%20Library/Requirements%20and%20VV%20Guidelines.doc>
- [3] Templates and Toolbox User Manual 03.00.00
<https://extranet.sesarju.eu/Programme%20Library/Templates%20and%20Toolbox%20User%20Manual.doc>
- [4] EUROCONTROL ATM Lexicon
<https://extranet.eurocontrol.int/http://atmlexicon.eurocontrol.int/en/index.php/SESAR>

7.2 Reference Documents

The following documents were used to provide input/guidance/further information/other:

- [5] 07.02-D28 Step 1 Release 4 DOD, Edition 00.03.00, July 2015.
- [6] ATFCM Operations Manual edition 16.0 [OI-12- Slot Swapping Procedure Update- April 19, 2012]
- [7] User Driven Prioritization Process (UDPP) Step 2 V2 OSED, Deliverable D07, Edition 00.00.01.
- [8] UDPP Step1 Safety and Performance Requirements, SESAR Deliverable D68, Edition 00.01.00, 30/09/2015.
- [9] SESAR Concept of Operations Step 1 Final Edition, Edition 00.02.02, Deliverable ID D124, 22/07/2015.
- [10] Integrated Roadmap Dataset 14, SESAR Extranet.
- [11] ATFCM Operations Manual, Network Manager, version 19.2, 20/10/2015.
- [12] Step 1 V3 UDPP Validation Report, D67, Edition 00.01.00, 30/09/2015.

Appendix A UDPP, High Level Principles

This section provides complementary useful information to understand the continuity of principles and rules between UDPP Step-1 and Step-2. It comes from the OSED for Step 2 [7].

1. The methodology and process of UDPP must at all times remain wholly transparent to all stakeholders.
2. The UDPP process and infrastructure will be easily and readily accessible, and be user-friendly to all actors.
3. Before UDPP is considered between AUs there must be binding agreements between the actors involved.
4. AUs have the right not to participate in UDPP without prejudice.
5. When a request for prioritisation is made, a response shall be required.
6. When UDPP is used, it is currently assumed that there shall be no negative impact on the network (i.e., airport and airspace).
7. The details of all process transactions shall be recorded and automatically and periodically made available to AUs.
8. The process shall be monitored to ensure that blocking tactics cannot be utilised. Such requests from AUs will be refused.
9. UDPP shall abide by Airport Slot rules.
10. UDPP transactions involving a financial compensation mechanism should be avoided. AUs should experience benefits over the medium/long term.

Appendix B

This section provides complementary useful information and technical constraints and rules to be applied in the slot-swapping procedure.

B.1 NMOC Slot-Swapping rules and constraints¹⁰

SLOT-SWAPPING RULES AND CONSTRAINTS

| TODAY | WHAT IS WANTED |
|--|---|
| Slot-swap effect in the system | |
| | |
| <p>After swap: B gets F (forced) A gets W (unforced)</p> <p><i>Note: forced=somebody worked on it; you have to go in the op-log to see what intervention was done, why is the reason this flight is forced</i></p> | <p>CR_035232: - flight A REF time gets ETO + delay - flight B REF time gets ETO - delay</p> |
| Basic Slot-Swapping | |
| Same MPR | No change |
| Compatible RVR minima | No change |
| flight B: new CTOT not earlier than Clock + Taxi-time + TIS | No change |
| slot issued status | See pre-allocated slot-swap below flight B needs to be RFI |
| slot not in "overload" status, nor "booked" / "blocked " | No change |
| slot not forced (forced=frozen); can be "Unfrozen" | No change |

¹⁰ in Slot-Swapping rules & constraints.xls v5_04.06.2013
[Co-defined with NMOC Slot-Swapping Task-Force]

| TODAY | WHAT IS WANTED |
|---|---|
| Basic Slot-Swapping | |
| Same Commercial agreement group(no system check: on responsibility of AU only) | <i>No change</i> |
| flight not already swapped | see Multi-swap below |
| new CTOT not earlier than TTOT (CDM apt) or ETOT (non-CDM) | <i>No change</i> |
| Network Impact Display (NID) rules: - swap should not create overdeliveries in other regs - swap should not lead traffic counts over declared capacity into non-regulated sectors | <i>No change</i> |
| system parameter: swap can be performed up to 10min after off-bock time | both flights should have future CTO |
| Multi-swap | |
| | allow multiple swapping |
| Pre-allocated slot-swap | |
| | 1 flight in pre-alloc status, the other one in slot-issued status |
| Most Penalising Delay | |
| | same DEP CDM APT |
| | delay CDM APT > delay MPR |

Appendix C Early Considerations of the Benefits

This appendix presents the description of benefits as described in the interim version of the OSED (version 1.00, dated 30/04/2013).

C1 The UDPP Step 1 Benefit approach

UDPP step1 is expected to bring benefits to Airspace Users through two main mechanisms:

- the ability to swap two flights in sequence, exchanging an expensive delay for a cheap delay by allocating delay to less strategic flights when possible;
- the ability to prioritize flights for cancellation during severe capacity limitations (e.g. due to weather).

These swaps (or prioritizations) could be conducted within a company or with another company under clear commercial agreements in line with UDPP rules, in either case without affecting overall Network delays. UDPP doesn't directly impact on the cost of ANS services, but may significantly reduce the indirect costs by reducing the losses incurred by AU in case of significant delays or cancellations.

One issue with the description of the benefits is that they do not fit into the existing SESAR Step 1 Performance Targets set for the main 5 Key Performance Areas (Airspace Capacity, Airport Capacity, Cost-Effectiveness, Predictability, and Flight Efficiency), particularly due to the indicators used to define these KPAs – for example, cost-effectiveness is ANS-focused and relates to ATCO productivity. Thus the KPIs do not reflect the UDPP benefits to Airspace Users, who are more interested in the impact on the cash flow cost to their operations (i.e. indirect costs due to delays or cancellations).

Therefore UDPP has elicited other KPIs to represent its impact on performance along the 5 main KPA. This approach can be represented by the following diagram, which takes a top-down look at the improvement on cost for the AUs, and attempts to break it down to understand potential KPIs.

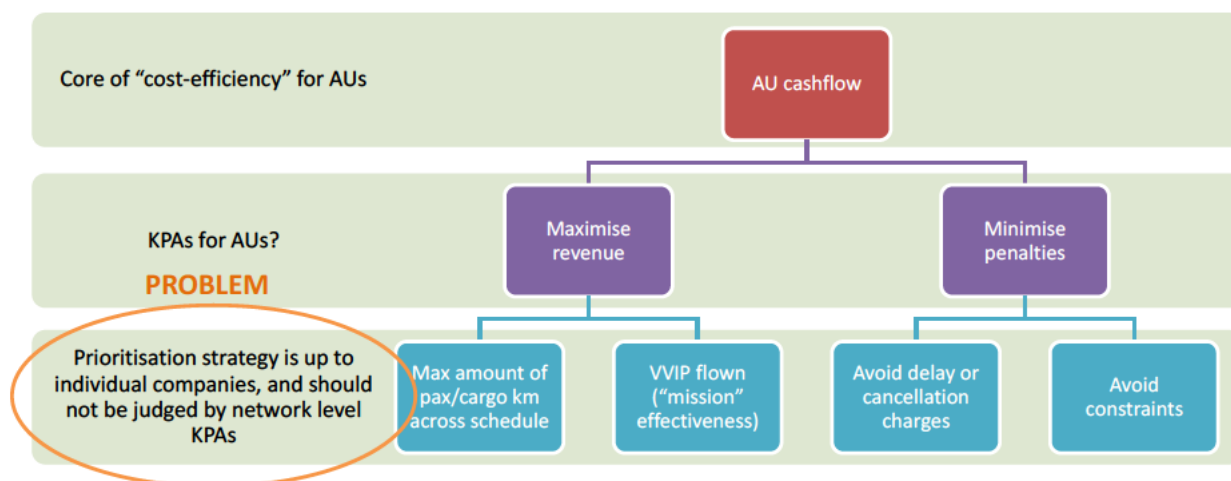

Figure C1: KPA for AU cost-efficiency

The Airspace Users in 07.06.02 agreed that the core KPAs were to maximize revenue and minimize penalties. The ability to translate this into Key Performance Indicators is highly dependent on the unique operations of each individual user; therefore, it was felt that agreeing a single set of KPIs to describe the benefit would not be appropriate for UDPP.

Instead, the group agreed that the approach taken would be based on real-life scenarios, as described by operational control centers in airlines, or by individual companies or airspace users. These scenarios are used to identify potential savings or maximization of revenue, during a time critical capacity shortfall. The savings fall into many different categories, some of which are captured below.

A separate mechanism is also described for the Network, which acts as an enabler of the primary benefits of UDPP through the provision of flexibility. A KPI may be developed to measure this flexibility.

C2 The AU View

C2.1 Scheduled carriers, including hubs

The benefits mechanism for scheduled carriers has been drafted based on a series of desk exercises examining real operational days where severe capacity reductions were seen, and analyzing what UDPP could have done to help.

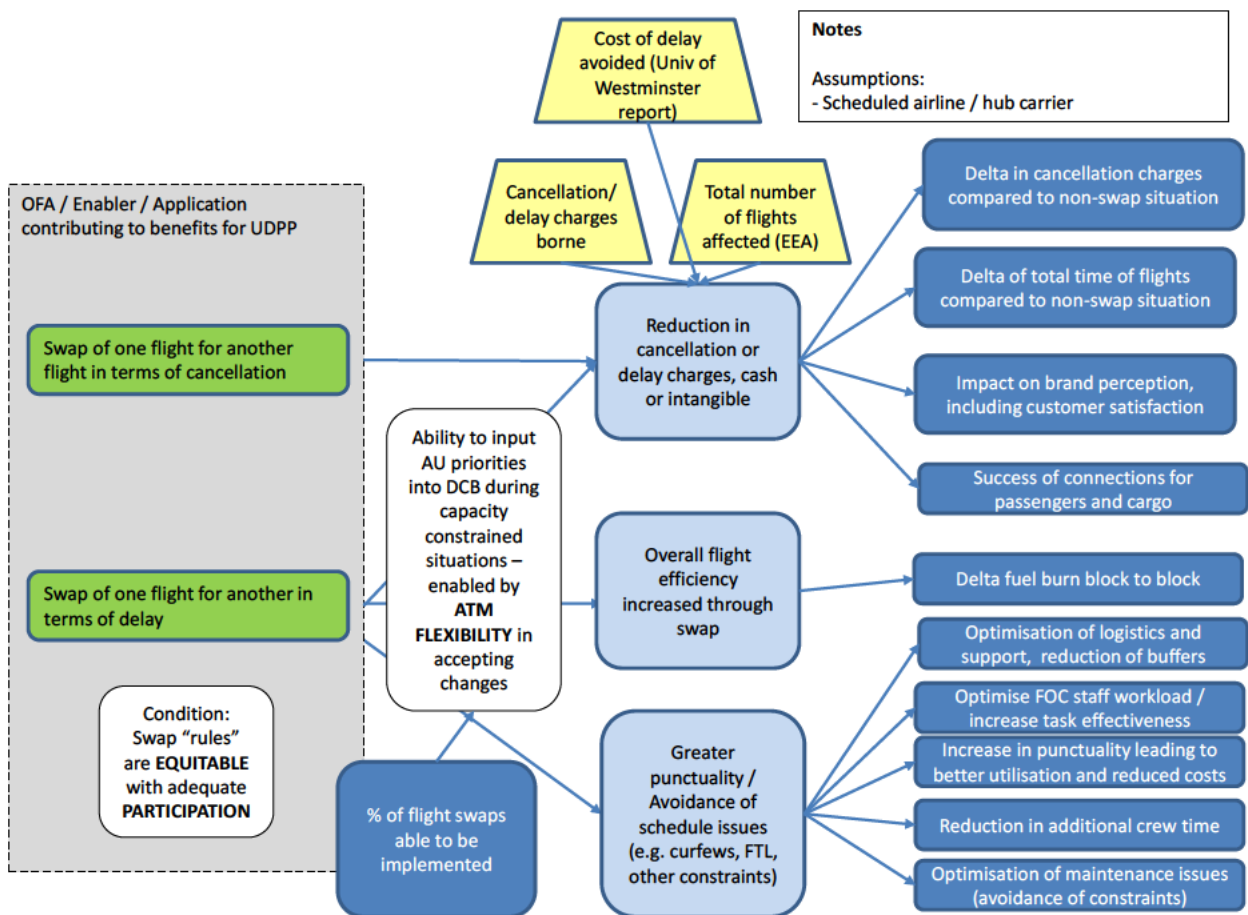

Figure C2: Simplified benefits mechanism for scheduled carriers

The main three impacts as a result of the enabling UDPP “application” are:

- a reduction in cancellation or delay charges, either measured in cash or intangibly (e.g. brand perception);
- greater punctuality, or avoidance of schedule issues (e.g. curfews, flight duty constraints, etc);

- an increase in the overall flight efficiency due to the swap.

These can be measured through a number of scenario based KPIs, shown in the dark blue boxes on the right of the diagram above. Several comments can be made on these KPIs. Some are intangible and cannot be measured – for example, the customer satisfaction. Others relate to the wider operations of the airline, for example the optimization of maintenance issues, the reduction of additional crew time, removal of “buffers” in logistics and support, and the optimization of task effectiveness in the operations centre. Finally, some KPIs are tangible, including the decrease in cancellation charges, decrease in total flight time, fuel burn block-to-block, and overall punctuality. Although the latter KPIs are measurable, they should not be seen as automatically the most important.

C2.2 Non-scheduled traffic, including Business and General Aviation

The main specificity of Business/General Aviation is to allow the users to take off and land from any runway in the world; a runway which can be a short runway (even less than 1000 ft) or the runway of a hub airport, in a non-scheduled manner.

1. **Operations at hubs:** Business Aviation operates at hub airports when the hub is considered as the most convenient airport for the mission of the customer: this indicates why Business Aviation operations at hubs are limited. Another reason to operate to or from the hub is to allow quick connections for high revenue passengers of airlines.

2. **Flexibility:** One of the specificity of Business and General Aviation is the capacity to change the destination airport even in flight in case of last minute incidents. The London TMA contains 23 airports; this gives the opportunity in case of problems at Heathrow to select another airport. This means also that these airports have to be suitable for Low Visibility Profile operations; this explains the interest of Business Aviation for autonomous systems: e.g. LVP (Low Visibility Procedure), HUD (Heads-Up Display), EVS (Equipment Visibility System).

3. **The requirements at hubs:** In normal operations; the main need for Business Aviation is to be allowed to take off as soon as the passengers are there. This means that when a business aircraft is at a hub to pick up a passenger arriving on a scheduled commercial service, the slot has to be “in liaison” with the real arrival time of the airline.

In case of sudden reduction of airport capacity, the business aircraft will accept to be diverted to other airports. There is a need for business aircraft to avoid remaining stuck at the hubs and to obtain through UDPP negotiations some priorities (in exchange of landing diversions).

4. **UDPP and Business / General Aviation:** Keeping in mind NetJets as an exception, most of Business or General Aviation operators have a limited number of aircraft. This means that BA or GA at hubs will have difficulties to appear as a group in the UDPP negotiations, even by some aspects Business Aviation operators will be competitors. Fixed Based Operators (FOB) provide services to Business Aviation aircraft on station. At hubs FOBs might be of help to organize the demands and negotiations for Business or General Aviation.

In general, these principles help explain why it is difficult to pinpoint benefits mechanisms for non-scheduled traffic such as Business Aviation (BA) or General Aviation (GA). Since most of the operators do not have utilization issues (i.e. aircraft are used less per day than for airlines), there is more slack in the system to deal with delays, and knock-on effects are less likely. Nevertheless, the key indicators (drivers) are customer satisfaction and thus brand perception, and linked to this, the ability to carry out the required flight (i.e. value of the flight happening compared to not happening). Figure C3 shows the simplified benefits mechanisms for non-scheduled operations (i.e. BA/GA).

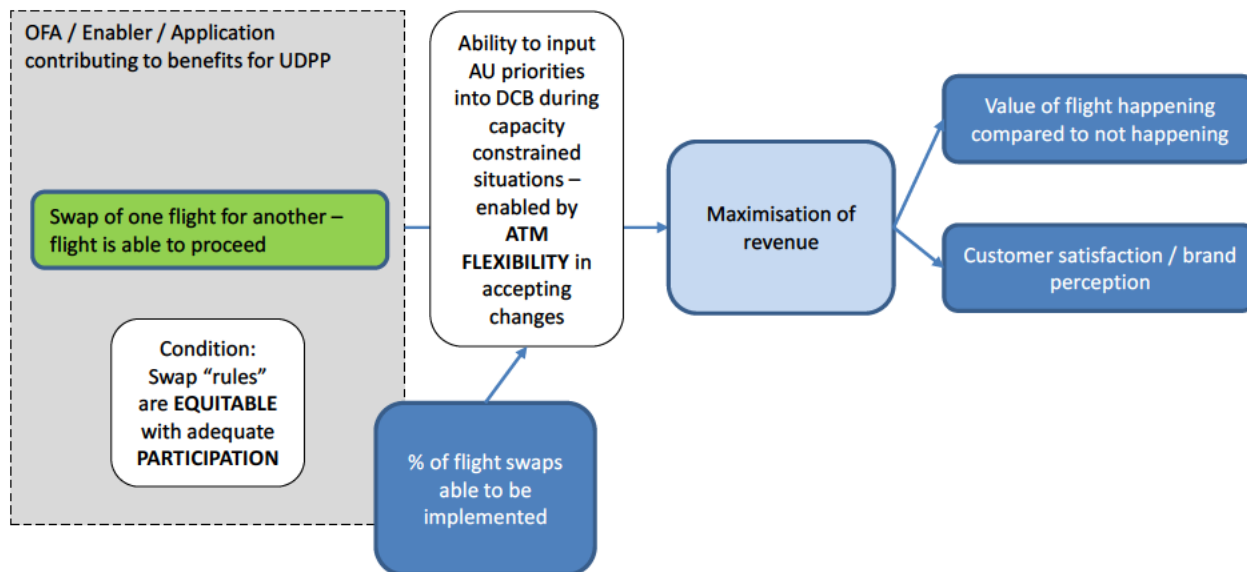

Figure C3: Simplified benefits mechanism for non-scheduled traffic

C3 The Network View

The Benefit Mechanism for UDPP Step 1 is described in the form of an Influence Diagram as suggested in the SESAR Performance Guidance material (SJU P16.6.6 -D10-02 ‘Step 1 V3 UDPP Final OSED’, 00.02.01, Jan 2012).

The following Influence Model represents the benefit mechanism of UDPP Step1 for the Network.

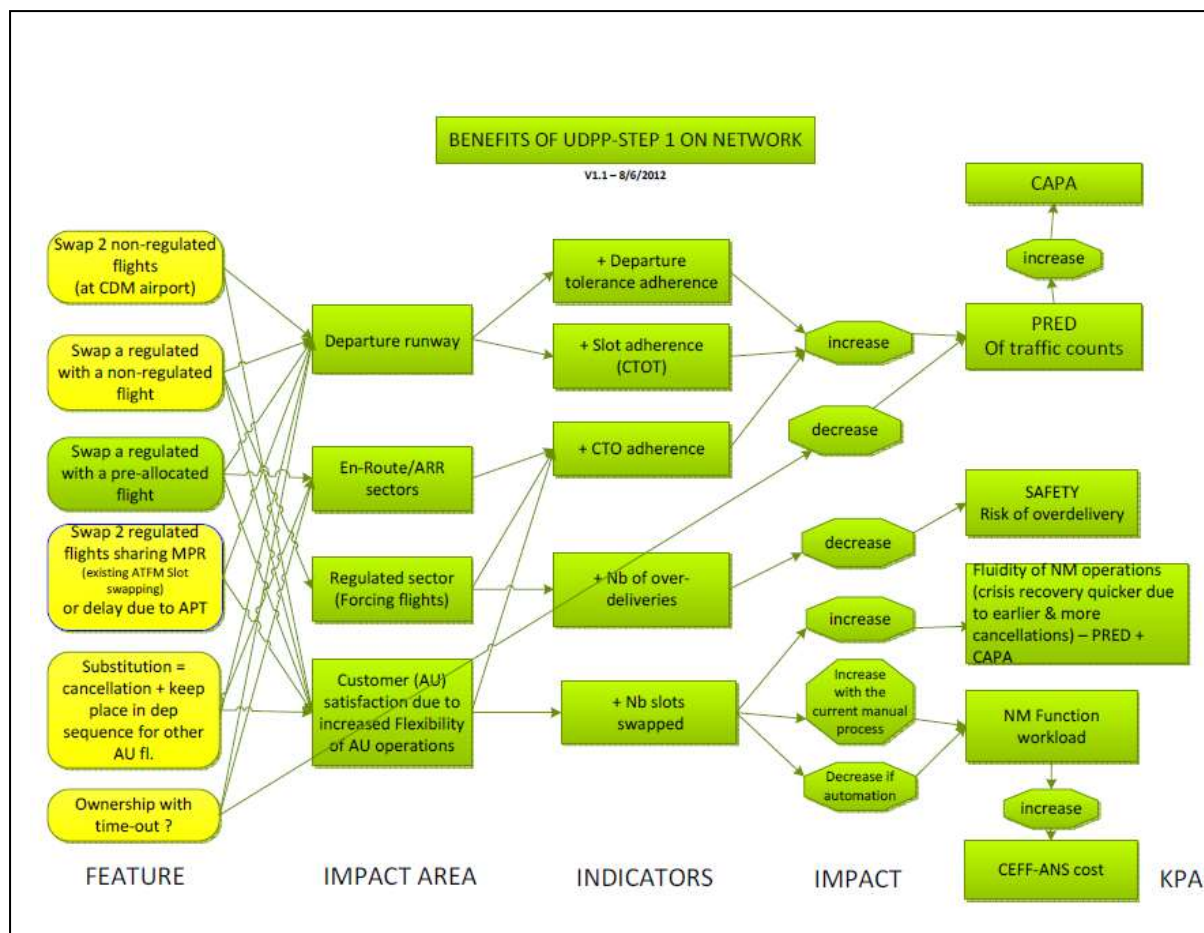

Figure C4: Influence Diagram for Network Benefits of UDPP

It should be read from left to right, starting from the new features (FEATURE column) introduced by UDPP Step 1 down to the Key Performance Areas affected by those new features in the European Air Transport (KPA column), and here in particular on the ATM Network.

The Yellow FEATURES are those affecting only the DEP airport, the Green one is an enhancement to the ATFM slot swapping which scope is multi-airport. The other enhancement of ATFM slot swapping, the Multi-swapping –i.e. the possibility to swap a flight several times and not only once as it is now-, is not described here as it is considered that the benefit mechanism is the same as for the simple swap.

The IMPACT AREA column represents the area of direct impact of the new feature.

- Here, all features impact the Departure runway sequence and have a positive influence on the Customer (AU) satisfaction.
- All features dealing with regulated flights affect the En-Route and/or ARR sectors.
- The swap of regulated with pre-allocated flight affects the regulated sector with the forcing of flights.

The INDICATORS column indicates how the influence can be measured.

- Following the latter influence further, the Indicator is the Number of over-deliveries to ATC which may result into a decrease of Safety.
- The influence on Departure runway can be measured through the Adherence to Departure tolerance and through the Adherence to slots (CTOT: Calculated Take-Off Time).
- The influence on sectors can be measured through the adherence to CTO (Calculated Time Over)
- Finally, the AU customer satisfaction can be measured by an expected augmentation of the number of swaps.

The next column represents the nature of the expected IMPACT on performance, basically either decrease or increase the performance area indicated in the last column KPA.

- All features that increase the adherence to time constraints increase at the same time the predictability of traffic counts (PRED) which results in an increase of capacity (CAPA).
- An increase of the over-deliveries to ATC decreases the SAFETY by augmenting the risk.
- The augmentation of the number of swaps has been found to have 2 effects:
 - In case of critical situation, it augments the fluidity of NM operations, in particular by accelerating the recovery by facilitating earlier (and potentially more?) cancellations: again it brings both PREDictability and CAPAcity.
 - In all situations, it has an effect on the Network Management Function (NMF) workload: an increase with the current manual process, a automated decrease if the swaps are automated. This impact of NMF workload has an impact on the KPA Cost-Effectiveness, in particular on the Cost of Air Navigation Services Cost(CEFF-ANS cost).
- Finally, the potential FEATURE ownership of slots is linked is directly to a decrease of PREDictability.

Appendix D Latest Understanding of the Benefits





Introduction

Seven benefit mechanisms are presented, one per concept feature. Following various validation activities in Step 1, the benefit mechanisms have been updated to present the current best understanding that the features have on performance.

How to Interpret a Benefit Mechanism

There are two parts to each mechanism: the **schematic**, which gives an overall impression of the impacts (i.e. benefits and disbenefits) that are known or expected, and the second part is a set of **detailed notes** that refer to specific branches of the schematic. These are essential for understanding why the impacts are known or expected.

Explanation of Coloured Arrows on the Schematics:

| | |
|---|--|
|  | A beneficial decrease e.g. a reduction in CO ₂ emissions (indicator) or a reduction in controller workload (positive impact) |
|  | A detrimental increase e.g. an increase in CO ₂ emissions (indicator) or an increase in controller workload (negative impact) |
|  | A beneficial increase e.g. an increase in the number of movements (indicator) or an increase in safety (positive impact) |
|  | A detrimental decrease e.g. a reduction in the number of movements (indicator) or a reduction in safety (negative impact) |
|  | A change in the indicator, a positive or negative impact is expected but with current knowledge the direction is still not clear. Can be coloured to show the main expectation. Where possible an up or down arrow is preferred. |

D.1 Feature 1/7: Pre-Allocated Slot Swap

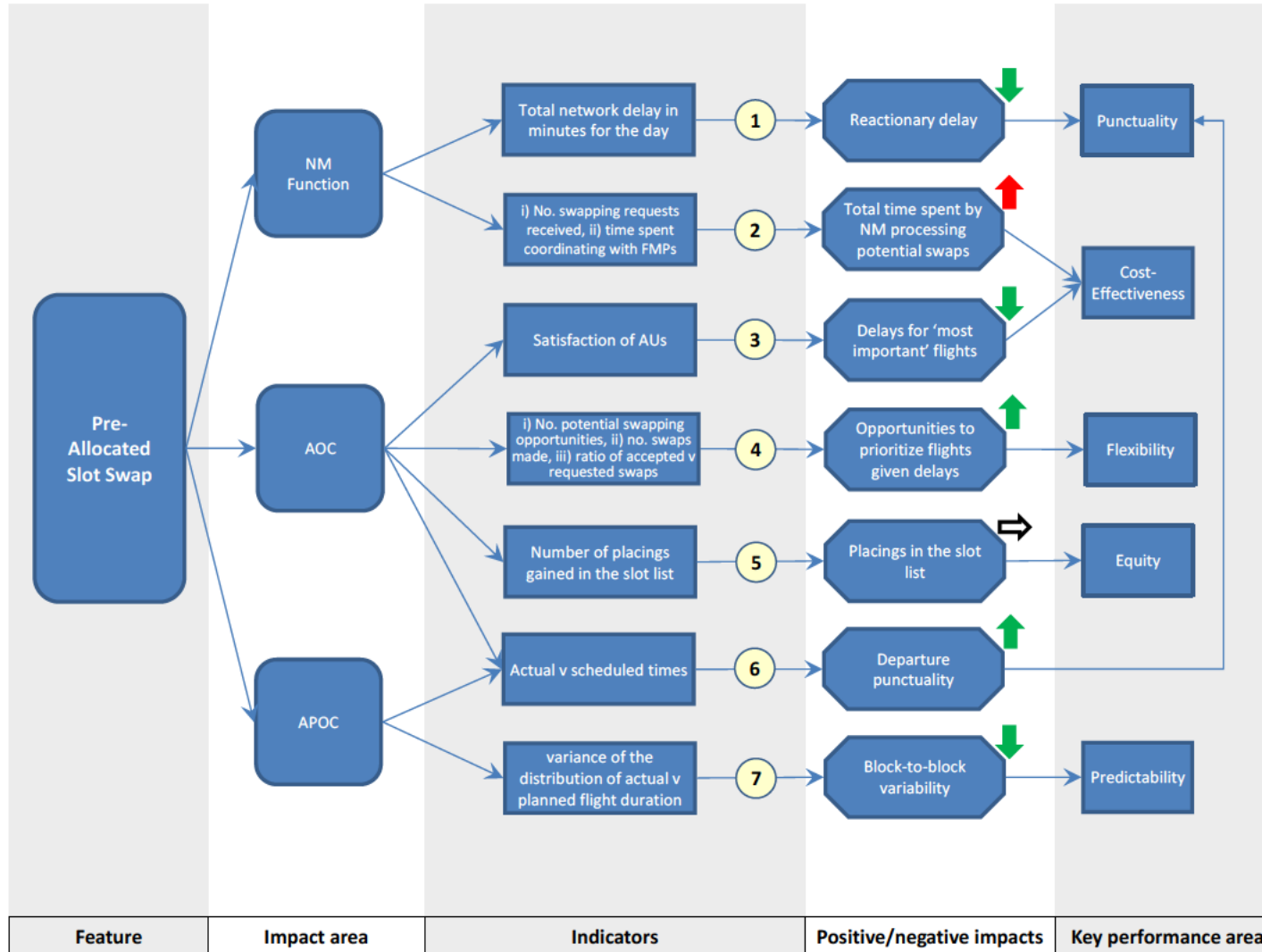

- (1) *The feature leads to more opportunities to swap slots which leads to more swaps which leads to airspace users choosing more often to absorb delays with flights with longer turn-around times which leads to reduced reactionary delay for the network [and therefore better punctuality for airspace users and the APOC.]*
- (2) *The feature leads to more opportunities to swap slots which leads to more swaps which leads to more time spent by the NM processing (evaluating and coordinating) swaps.*
- (3) **CONFIRMED BY VALIDATION:** *The feature leads to more opportunities to swap slots which leads to more swaps which leads to airspace users reducing the impacts of delay on more of their most important flights.*
- (4) **CONFIRMED BY VALIDATION:** *The feature leads to more opportunities to swap because promoted flights can be swapped again by the airspace user - they are not 'frozen'. [There is also a benefit in terms of flexibility for NM because promoted flights will no longer be constraints when recalculating slot lists.]*
- (5) *Because the feature swaps slots, this feature should not affect the placings of non-participating flights in the same list. However, there may be unintended changes to placings in other slot lists, but there should be no systematic effect.*
- (6) *See item (1). Furthermore, if two flights are delayed, and one transfers some of its delay to the other, the prioritized flight could become 'on time', thus punctuality could improve.*
- (7) *Slot allocation and swapping are processes that, in theory, only modify the flight plan's departure time. However, increased slot swapping leads to the most important flights having less or no delay (see item (3)), which may lead to less operational need for these important flights to speed up in flight to arrive closer to the scheduled arrival time, which would lead to better predictability (where predictability is defined as the difference between planned and actual flight duration).*

Note: *it was previously thought that this feature could lead to "foreseen and accepted" over-delivery in regulated and non-regulated sectors, and furthermore to empty slots in regulated sectors. If all reasonable swap requests are accepted by the NM operator, these undesirable outcomes may occur under certain specific conditions. However, provided that the NM operator checks that there is no undesirable impact on regulated and non-regulated sectors before accepting an ATFM swap (using the Network Impact Display tool, and coordinating with FMPs if necessary) there should be no risk of over-delivery or empty slots due to ATFM slot swapping.*

D.2 Feature 2/7: Multi-Swap of ATFM Slots

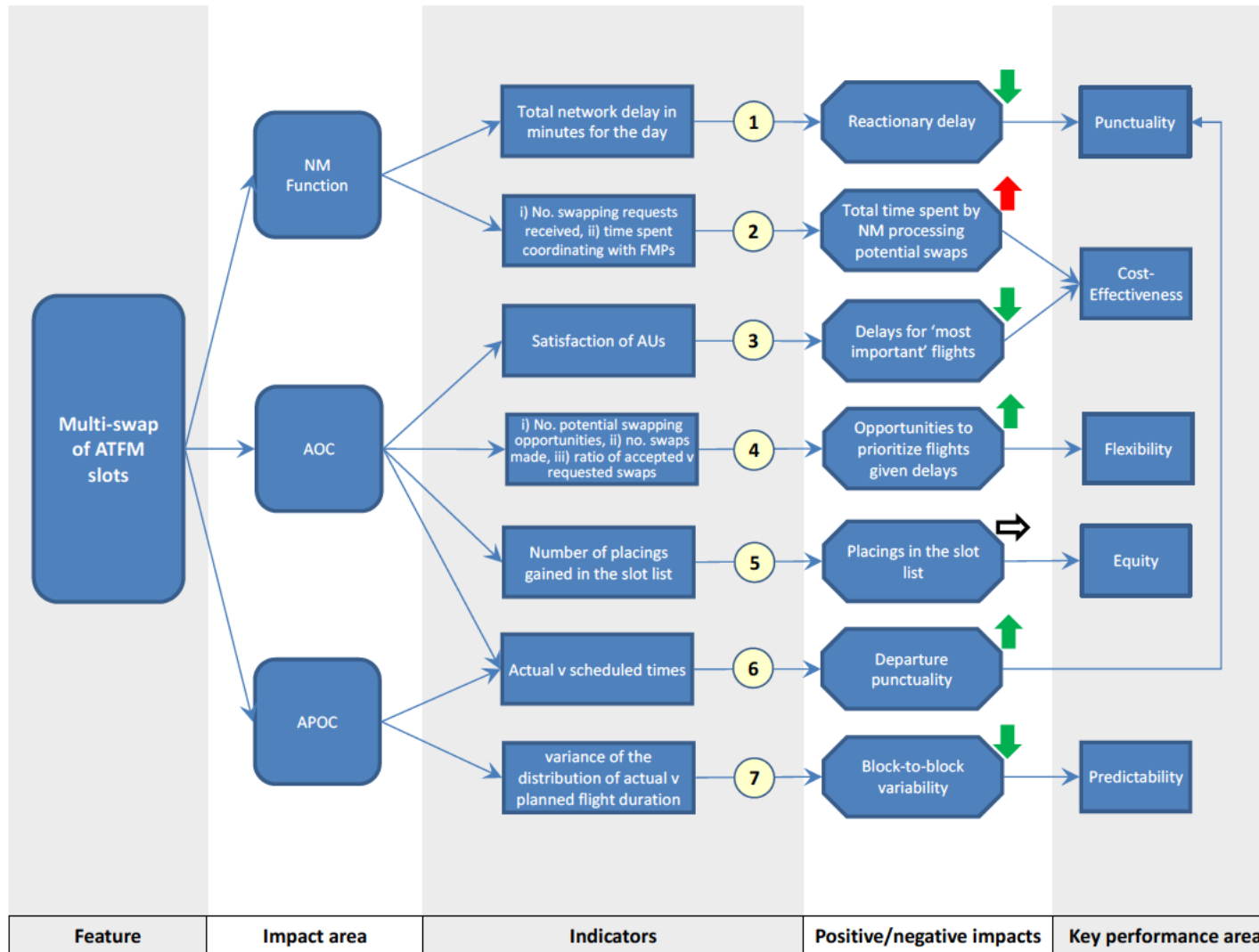

- (1) *The feature leads to more opportunities to swap slots which leads to more swaps which leads to airspace users choosing more often to absorb delays with flights with longer turn-around times which leads to reduced reactionary delay for the network (and therefore better punctuality for airspace users and the APOC).*
- (2) *The feature leads to more opportunities to swap slots which leads to more swaps which leads to more time spent by the NM processing (evaluating and coordinating) swaps.*
- (3) **CONFIRMED BY VALIDATION:** *The feature leads to more opportunities to swap slots which leads to more swaps which leads to airspace users reducing the impacts of delay on more of their most important flights.*
- (4) **CONFIRMED BY VALIDATION:** *The feature leads to more opportunities to swap because promoted flights can be swapped again by the airspace user - they are not 'frozen'. (There is also a benefit in terms of flexibility for NM because promoted flights will no longer be constraints when recalculating slot lists.)*
- (5) *Because the feature swaps slots, this feature should not affect the placings of non-participating flights in the same list. However, there may be unintended changes to placings in other slot lists, but there should be no systematic effect.*
- (6) *See item (1). Furthermore, if two flights are delayed, and one transfers some of its delay to the other, the prioritized flight could become 'on time', thus punctuality could improve.*
- (7) *Slot allocation and swapping are processes that, in theory, only modify the flight plan's departure time. However, increased slot swapping leads to the most important flights having less or no delay (see item (3)), which may lead to less operational need for these important flights to speed up in flight to arrive closer to the scheduled arrival time, which would lead to better predictability (where predictability is defined as the difference between planned and actual flight duration).*

Note: *it was previously thought that this feature could lead to "foreseen and accepted" over-delivery in regulated and non-regulated sectors, and furthermore to empty slots in regulated sectors. If all reasonable swap requests are accepted by the NM operator, these undesirable outcomes may occur under certain specific conditions. However, provided that the NM operator checks that there is no undesirable impact on regulated and non-regulated sectors before accepting an ATFM swap (using the Network Impact Display tool, and coordinating with FMPs if necessary) there should be no risk of over-delivery or empty slots due to ATFM slot swapping.*

D.3 Feature 3/7: Substitution on Cancellation

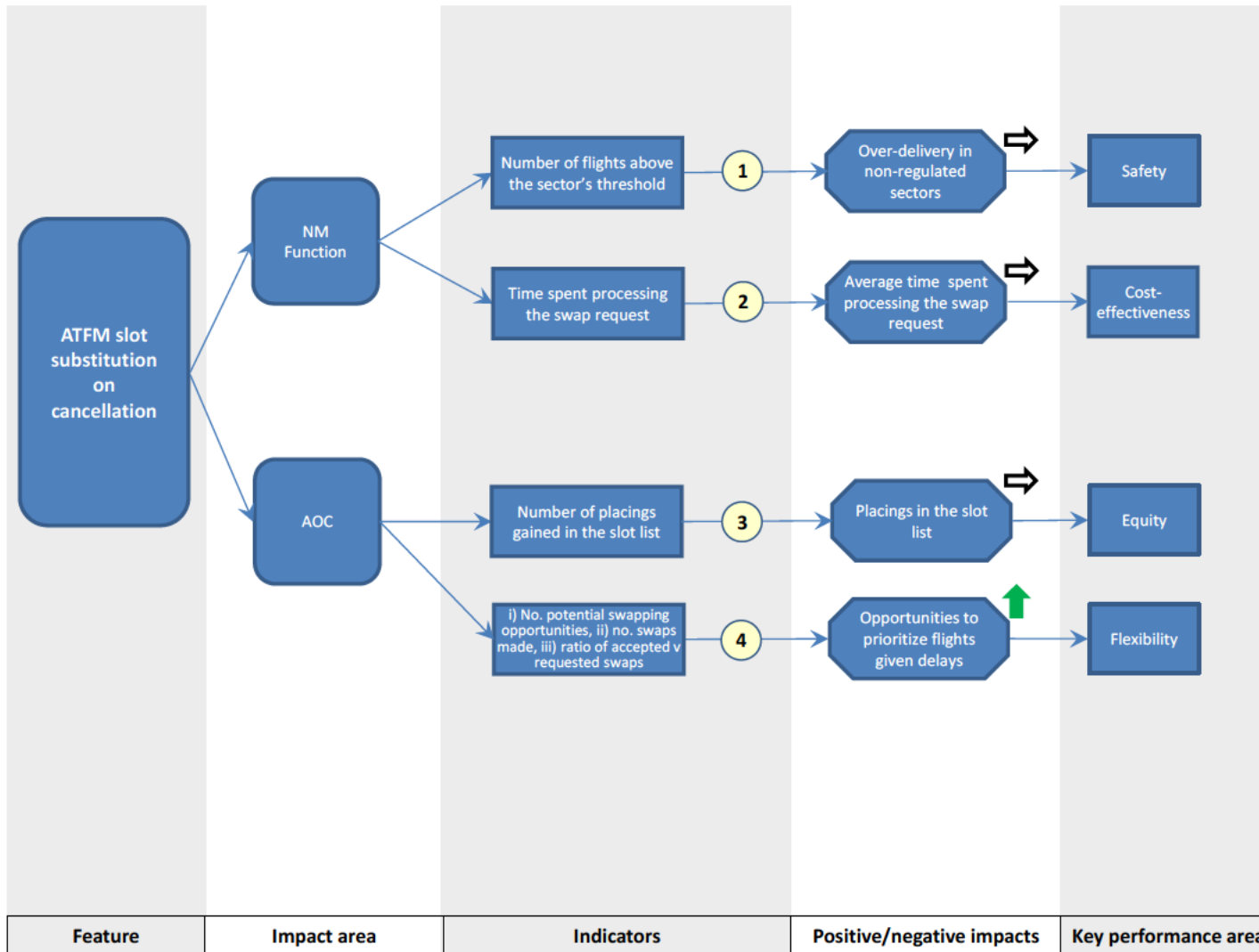

- (1) *The feature could lead to an over delivery in a non-regulated sector if the substituting flight has to depart shortly after the swap to make its new CTO (affected sectors may be able to split at short notice to cope, or it may be possible to subject the sectors to regulation if there is sufficient time.) and the NM operator fails to carry out a network impact assessment correctly prior to accepting the swap. The latter is very unlikely, of course, but it could be argued that a significant increase in the number of swap requests of this type would increase the chance of this error occurring.*
- (2) *The feature will take no longer to assess than any other type of slot swap requests **provided that** the NM operator does not have to manually suspend or cancel the flight that is to be cancelled.*
- (3) *This feature will not introduce a new concept, rather it will make something which is possible today via two steps (a swap then a cancellation) easier for the airline. Thus, equity should be no different compared to today. However, given the importance of equity it might be sensible to validate this claim.*
- (4) **CONFIRMED BY VALIDATION:** *This feature will give airspace users an easier alternative to what is already possible today. Today, a swap would be made, followed by the cancellation of the deteriorated flight. However, this concept feature will combine both the swap and the cancellation in one, and forego the safety check on the flight that will be cancelled. This feature gives a more 'flexible' approach for coping with delay because it is a single step and because there is a slightly increased chance it being accepted than the two step alternative. This loose interpretation of 'flexibility' is not aligned to SESAR's recent definition of flexibility.)*

D.4 Feature 4/7: Most Penalising Delay

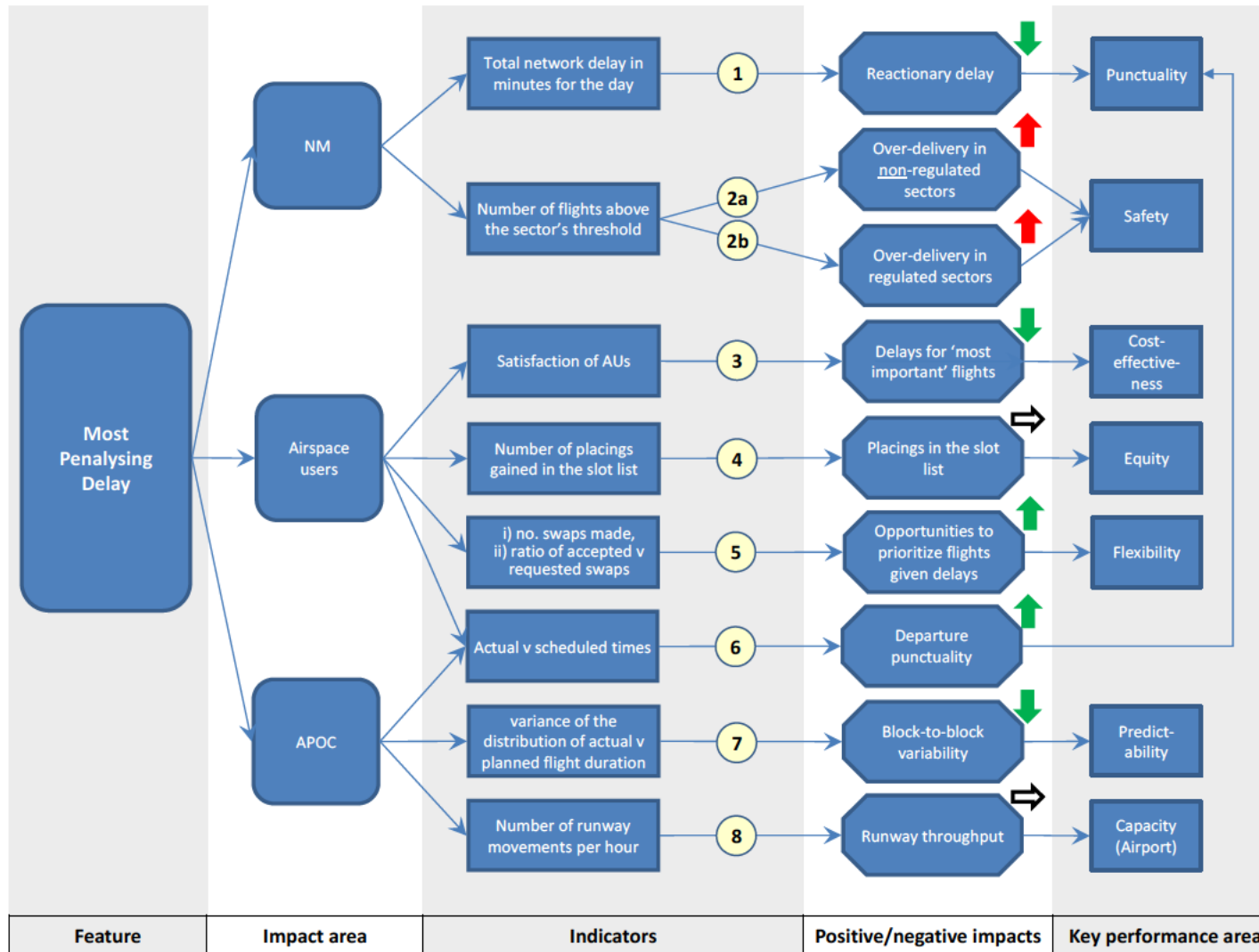

- (1) *The feature leads to more opportunities to swap slots which leads to more swaps which leads to airspace users choosing to delay flights that will have longer turn-around times at the next arrival airport (where delays can be better absorbed) which leads to reduced reactionary delay for the network (and therefore better punctuality for airspace users and the APOC at onward airports).*
- (2a) *The feature leads to more opportunities to swap slots which leads to more opportunities for non-regulated sectors to have traffic volume counts higher than the maximum threshold. (Affected sectors may be able to split at short notice to cope, or it may be possible to subject the sectors to regulation if there is sufficient time, or to apply a short-term ATFCM measure (STAM)¹¹.)*
- (2b) *Similar mechanism to that described in (2a) but concerns regulated sectors. This impact will disappear if the Network Manager can veto a swap at the airport, under the assumption that the Network Manager would not deliberately accept an over-delivery in a regulated sector. The fact that a sector is regulated anyway implies that ETFMS would soon reissue CTOs in reaction to a sudden change in the expected entry times due to a swap at the departure airport¹².*
- (3) *The feature leads to more opportunities to swap slots which leads to more swaps which leads to airspace users reducing the impacts of delay on more of their most important flights.*
- (4) *On average, airspace users that are not swapping flights will have the same placings in the pre-departure sequence before and after a swap. This is the expectation, and it would be sensible to verify this claim.*
- (5) *This feature will permit airspace users some say in how their delay is apportioned, so flexibility should increase.*
- (6) *See item (1). Furthermore, if two flights are delayed, and one transfers some of its delay to the other, the prioritized flight could become 'on time', thus punctuality could improve.*
- (7) *Slot allocation and swapping are processes that, in theory, only modify the flight plan's departure time. However, increased slot swapping leads to the most important flights having less or no delay (see item (3)), which may lead to less operational need for these important flights to speed up in flight to arrive closer to the scheduled arrival time, which would will lead to better predictability (where predictability is defined as the difference between planned and actual flight duration).*
- (8) *Runway throughput is unlikely to be affected because reordering happens before the tower calculates the departure sequence. However, under certain very specific conditions (e.g. a very late swap with other conditions) runway throughput could be reduced.*

¹¹ STAM is a new approach to deal with situations where demand exceeds capacity. The approach is to target a few flights that would best alleviate congestion. STAM would, it is hoped, replace regulations in many cases.

¹² The so-called 'True Revision' process is the re-evaluation and subsequent update of slot lists carried out within ETFMS, which is done every five minutes.

D.5 Feature 5/7: Departure Reference-Time Reordering

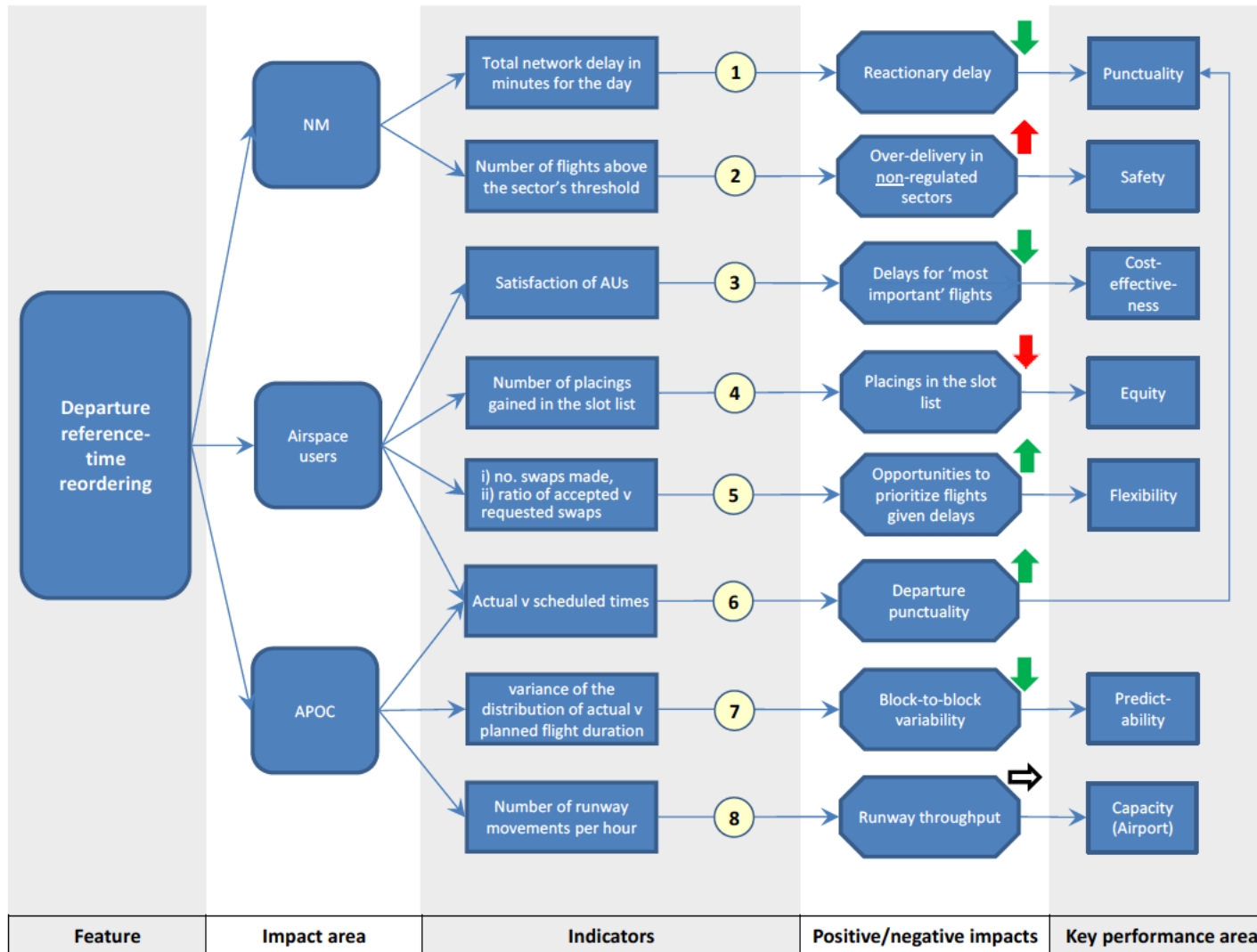

- (1) *The feature leads to more opportunities to swap slots which leads to more swaps which leads to airspace users choosing to delay flights that will have longer turn-around times at the next arrival airport (where delays can be better absorbed) which leads to reduced reactionary delay for the network (and therefore better punctuality for airspace users and the APOC at onward airports).*
- (2) *The feature leads to more opportunities to swap slots which leads to more opportunities for non-regulated sectors to have traffic volume counts higher than the maximum threshold. (Affected sectors may be able to split at short notice to cope, or it may be possible to subject the sectors to regulation if there is sufficient time, or to apply a short-term ATFCM measure (STAM).)*
- (3) **CONFIRMED BY VALIDATION:** *The feature leads to more opportunities to swap slots which leads to more swaps which leads to airspace users reducing the impacts of delay on more of their most important flights.*
- (4) **CONFIRMED BY VALIDATION:** *The DFlex demonstration has shown that flights that don't swap, but that are nearby in a temporal sense to others that do, accrue delay on average.*
- (5) **CONFIRMED BY VALIDATION:** *SESAR's definition of the Flexibility key performance area broadly concerns the accommodation of requests of airspace users. As far as this feature is concerned, all requests regarding swaps are accepted provided the swapping rules and constraints are satisfied. This feature will permit airspace users some say in how their delay is apportioned, so flexibility should increase.*
- (6) *See item (1).*
- (7) *Slot allocation and swapping are processes that, in theory, only modify the flight plan's departure time. However, increased slot swapping leads to the most important flights having less or no delay (see item (3)), which may lead to less operational need for these important flights to speed up in flight to arrive closer to the scheduled arrival time, which would lead to better predictability (where predictability is defined as the difference between planned and actual flight duration).*
- (8) **CONFIRMED BY VALIDATION:** *runway throughput is unaffected.*

D.6 Feature 6/7: First Priority for Departure

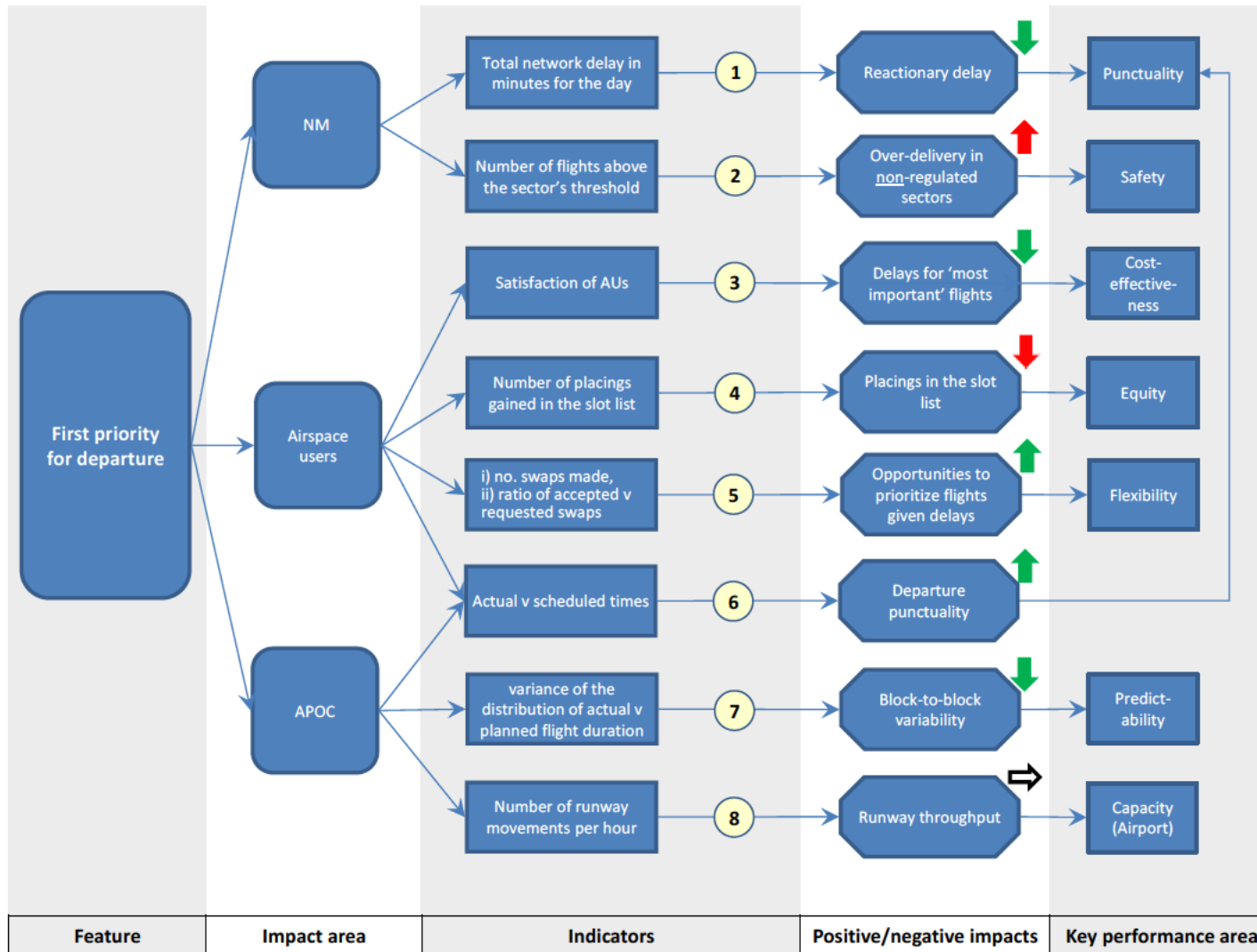

- (1) *The feature leads to more opportunities to swap slots which leads to more swaps which leads to airspace users choosing to delay flights that will have longer turn-around times at the next arrival airport (where delays can be better absorbed) which leads to reduced reactionary delay for the network (and therefore better punctuality for airspace users and the APOC at onward airports).*
- (2) *The feature leads to more opportunities to swap slots which leads to more opportunities for non-regulated sectors to have traffic volume counts higher than the maximum threshold. (Affected sectors may be able to split at short notice to cope, or it may be possible to subject the sectors to regulation if there is sufficient time, or to apply a short-term ATFCM measure (STAM).)*
- (3) **CONFIRMED BY VALIDATION:** *most important flights benefit from reduced delay.*
- (4) **CONFIRMED BY VALIDATION:** *flights that don't swap, but that are nearby in a temporal sense to others that do, accrue delay on average.*
- (5) **CONFIRMED BY VALIDATION:** *airspace users are better able to cope with delay if using this feature.*
- (6) *See item (1).*
- (7) *Slot allocation and swapping are processes that, in theory, only modify the flight plan's departure time. However, increased slot swapping leads to the most important flights having less or no delay (see item (3)), which may lead to less operational need for these important flights to speed up in flight to arrive closer to the scheduled arrival time, which would will lead to better predictability (where predictability is defined as the difference between planned and actual flight duration).*
- (8) **CONFIRMED BY VALIDATION:** *runway throughput is unaffected.*

D.7 Feature 7/7: Upwards Cascade on Departure Cancellation

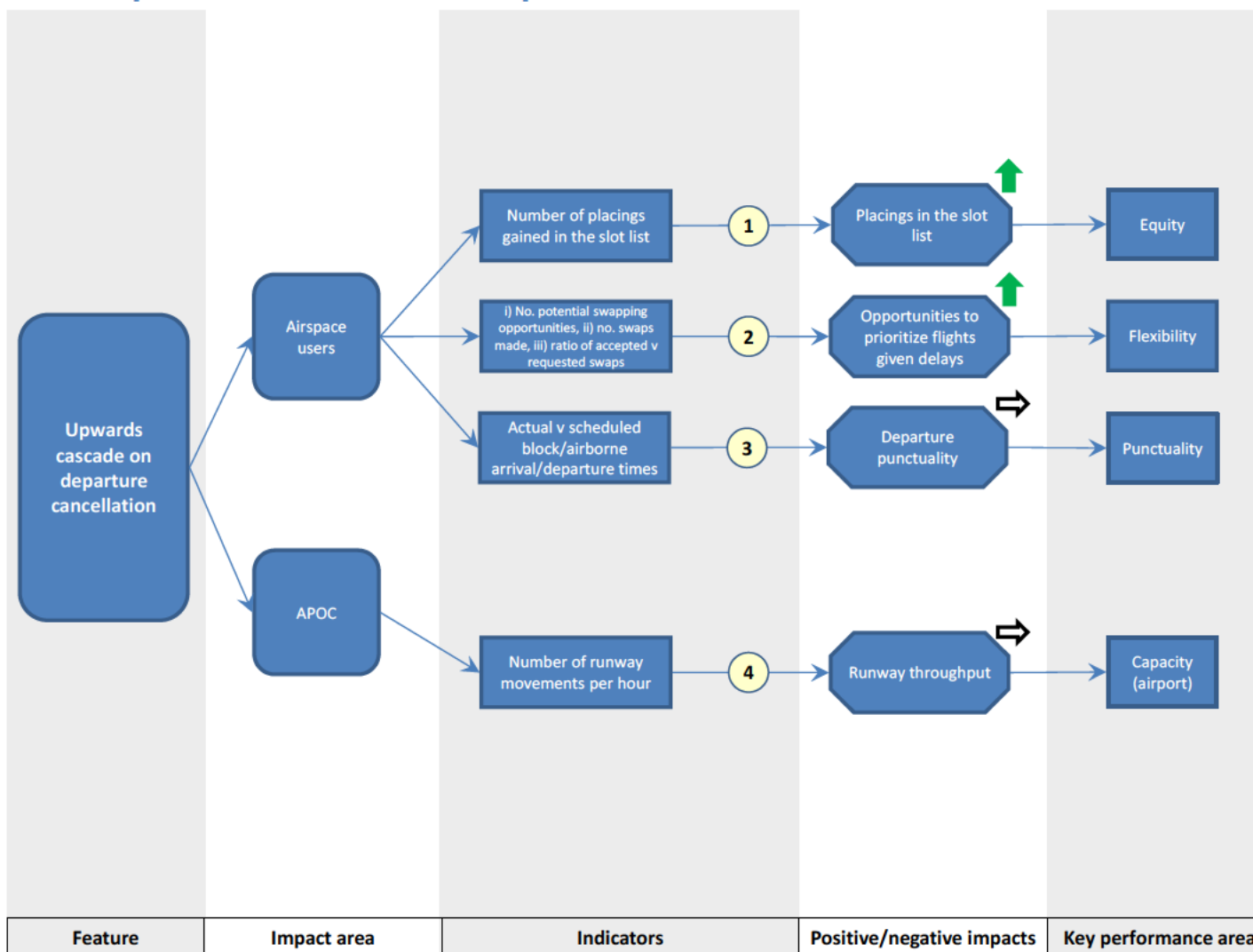

- (1) **CONFIRMED BY VALIDATION:** *on average, flights impacted by this DFlex action will experience an improvement in placings (and a reduction in overall delay).*
- (2) **CONFIRMED BY VALIDATION:** *airspace users are better able to cope with delay if using this feature.*
- (3) *If this feature didn't exist the pre-departure sequencer would fill the empty slot anyway. The feature just prioritises one airspace user's flights to offset the cancellation. Thus, there should be no difference in average network punctuality at onward airports compared to today's situation (although the punctuality for the airspace user who is subject of the upwards cascade would have improved punctuality compared to today).*
- (4) **CONFIRMED BY VALIDATION:** *runway throughput is unaffected.*

-END OF DOCUMENT-